



High feed milling cutter

**ADD<sup>D</sup>FEED / DOFEED**

Tungaloy Report No. 545-G

# Ultimate high feed milling cutter series for maximum productivity





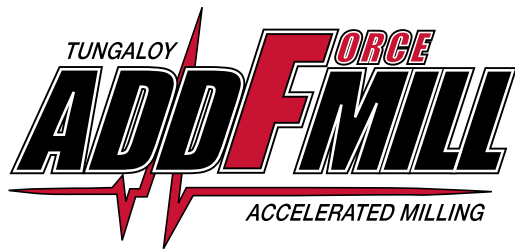

## ADD D FEED / DO FEED

---



High-feed cutters reduce machining time in  
a wide range of applications

## Complete high feed milling solutions

**New** **ADDDFEED**  
Insert size 02



Max. depth of cut: 0.5 mm  
Tool diameter: ø8 - ø25 mm

- ✓ Tool diameters as small as **8 mm**
- ✓ **Highly reliable design**
- ✓ Perfect option for **replacing solid end mills**

P.8 - 13

**DOFEED**  
Insert size 03



Max. depth of cut: 0.9 mm (UER), 1 mm (ZER)  
Tool diameter: ø16 - ø50 mm

- ✓ **Close pitch cutter design** for high productivity
- ✓ **Extensive lineup** for various applications
- ✓ **New UER inserts with small approach angle** for long tool life

P.14 - 25

**DOFEED**  
Insert size 06



Max. depth of cut: 1.5 mm  
Tool diameter: ø32 - ø200 mm

- ✓ **Close pitch cutter design** for high productivity
- ✓ Tool diameters available for up to 200 mm, ideal for **rough milling of medium- and large-sized components**
- ✓ **Wiper inserts** for improved surface roughness

P.26 - 31

### Tool diameters and number of teeth for each insert size

Insert size	Max. depth of cut (mm)	Workpiece material	Tool diameter (mm), Number of teeth																						
			ø8	ø10	ø12	ø16	ø18	ø20	ø22	ø25	ø28	ø30	ø32	ø35	ø40	ø50	ø52	ø63	ø66	ø80	ø100	ø125	ø160	ø200	
02	0.5	P M K S H	1	2	2	4	3	5	4	7	6														
03	0.9 (UER) 1 (ZER)	P M K S H				2	2	4	3	4	3	5	4	5	4	5	5	6	6	5	6				
06	1.5	P M K S H										2	2	3	4	5	4	4	4	6	5	6	8	10	12

# Features for DoFeed series

## ■ Cutter body design for maximum productivity

Extremely stiff body design with a large core



Close pitch cutter design for increased productivity

■ Inserts per diameter density comparisons:  
DoFeed series vs competitor's high feed cutter

Tool diameter (mm)	ADDFEED	DOFEED 03	DOFEED 06	Competitor
ø16	4	2	-	2
ø25	7	5	-	4
ø50	-	8	5	4

## ■ Reliable and economical inserts

Economical double-sided inserts with four cutting edges

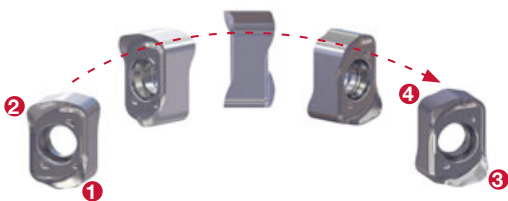

Thick insert design for increased reliability

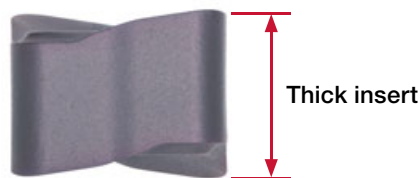

## ■ Soft cutting geometry with superior chip control

■ Comparison of spindle load

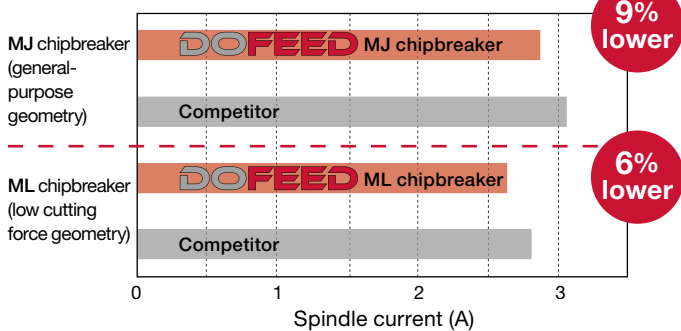

Provides stable, high productivity due to the excellent chip evacuation

Forms compact chips



- P** Cutter : EXN03R025M25.0-05 (ø25 mm, CICT = 5)  
 Insert : LNMU0303ZER-MJ / ML AH725  
 Workpiece material : S55C / C55  
 Cutting speed :  $V_c = 250$  m/min  
 Feed per tooth :  $f_z = 0.5$  mm/t  
 Depth of cut :  $a_p = 0.5$  mm  
 Width of cut :  $a_e = 25$  mm (Slot milling)  
 Coolant : Dry  
 Machine : Vertical M/C, BT40

Note: Test cut using a single insert

	DOFEED	Competitor
Chip shapes		
Shoulder surfaces after grooving operations		

# ADDDOFEED / DOFEED

## GRADES

### Addition of AH3225 grade for enhanced insert grade lineup

Grades with long tool life for a wide range of materials

New

## AH3225

**P M**

- Nano multi-layer coating technology with three major properties for optimal cutting edge integrity
- Increased resistance to wear, fracture, oxidation, built-up edge, and delamination

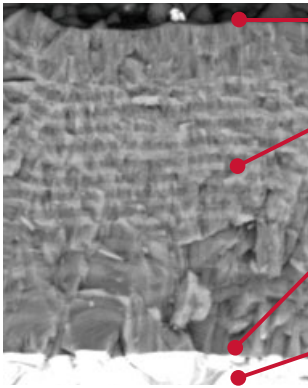

#### Resistance to built-up edge

The coating surface prevents built-up edge

#### Resistance to wear, oxidation, and fracture

Multi-layered coating is designed to resist wear and oxidation, while preventing micro-cracks from propagating in the coating layer for improved resistance to edge chipping

#### Strong coating / substrate adhesion

Coating is optimized for strong adhesion property with substrate to maintain strong cutting edge integrity

#### Carbide substrate

High resistance to fracture

## PREMIUMTEC

### AH120 **K**

- Exceptionally wear resistant in cast iron machining

### AH8015 **P K H**

- High wear and chipping resistance and minimized built up edge due to nano multi-layered AlTiN coating with high Al content
- Well-suited for difficult materials of 45 - 55 HRC

### AH8005 **H**

- High wear and chipping resistance and minimized built-up edge due to nano multi-layered AlTiN coating with high Al content
- Ideal for hardened steel of 55HRc and above

### AH130 **M S**

- High chipping resistance
- Ideal for titanium alloy machining

## APPLICATION AREAS

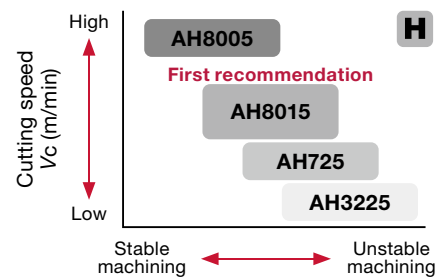
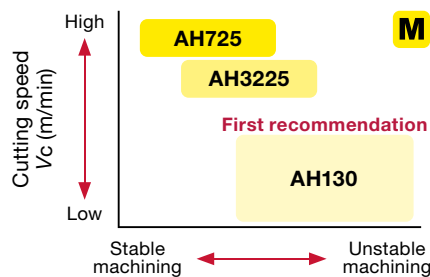
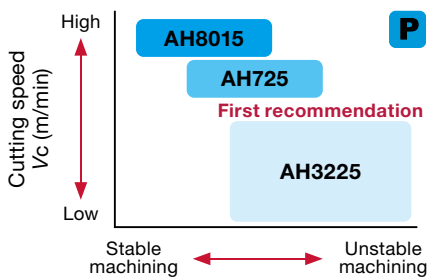

## CUTTING PERFORMANCE

Grade: AH3225

**P** S55C / C55 (190HB)

Insert size 02

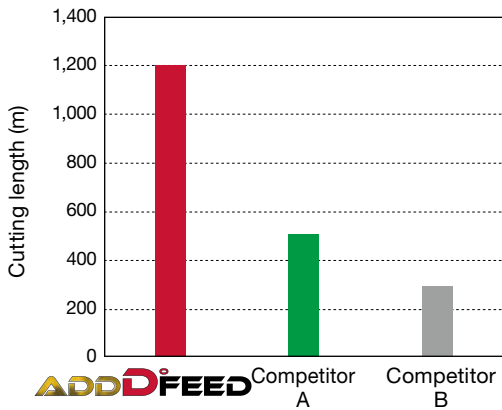

Cutter : EXN02R012M12.0-02 (ø12 mm, CICT = 2)  
 Insert : LNMU0202ZER-MM  
 Overhang length : 30 mm  
 Cutting speed :  $V_c = 250$  m/min  
 Feed per tooth :  $f_z = 0.6$  mm/t  
 Depth of cut :  $a_p = 0.4$  mm  
 Width of cut :  $a_e = 9.8$  mm  
 Coolant : Dry  
 Machine : Vertical M/C, BT40

Insert size 03

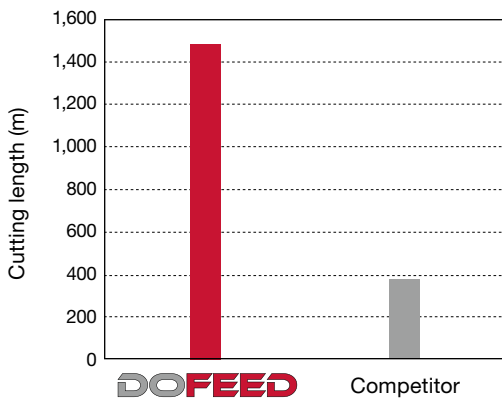

Cutter : EXN03R025M25.0-05-C (ø25 mm, CICT = 5)  
 Insert : LNMU0303ZER-MJ  
 Cutting speed :  $V_c = 200$  m/min  
 Feed per tooth :  $f_z = 1$  mm/t  
 Depth of cut :  $a_p = 0.6$  mm  
 Width of cut :  $a_e = 15$  mm  
 Coolant : Dry  
 Machine : Vertical M/C, BT50

Insert size 06

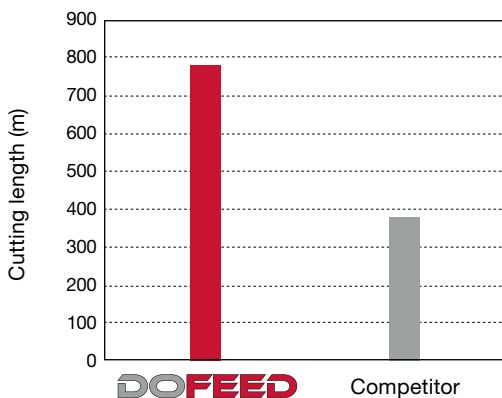

Cutter : TXN06R050M22.0E05 (ø50 mm, CICT = 5)  
 Insert : LNMU06X5ZER-MJ  
 Cutting speed :  $V_c = 150$  m/min  
 Feed per tooth :  $f_z = 1$  mm/t  
 Depth of cut :  $a_p = 1$  mm  
 Width of cut :  $a_e = 35$  mm  
 Coolant : Dry  
 Machine : Vertical M/C, BT50

## First choice for cutter diameters $\varnothing 8 - \varnothing 16$ mm

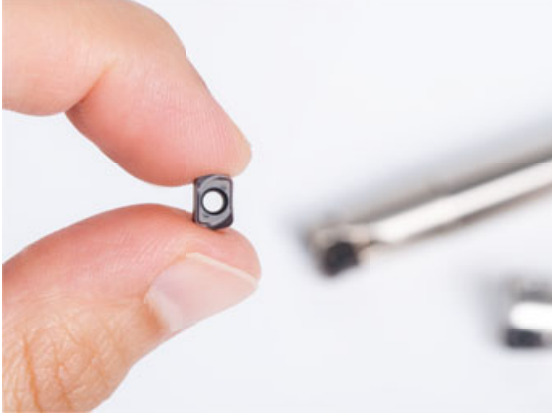

### High reliability

Three features of the insert design increase reliability of the small inserts, providing process security

#### 1. Thick insert

Insert with thickest possible design to prevent insert fracture.

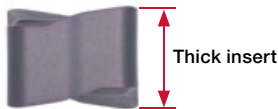

#### 2. Thick insert support

Sustains massive cutting loads generated during high feed machining.

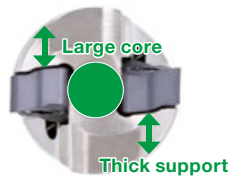

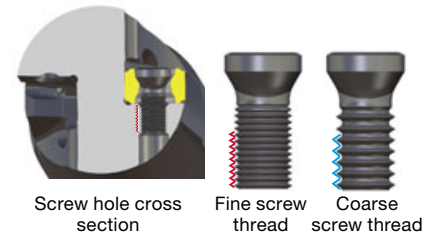

#### 3. Fine screw threads

Shallow-pitched fine threads prevent screw from self-loosening due to higher number of threads in contact.



### Use AddDoFeed for solid end mill to control chatter

Endmilling applications prone to chatter	ADD <sup>o</sup> FEED will...
<p>Long overhang (<math>\geq 4 \times D</math>), Grooving</p> 	<ul style="list-style-type: none"> <li>✓ Control chatter thanks to high feed insert geometry</li> <li>✓ Increase productivity thanks to controlled chatter</li> </ul>
<p>Corner radius with multiple edge contacts</p> 	<ul style="list-style-type: none"> <li>✓ Stabilize machining and increase tool life</li> <li>✓ Reduced tool costs and streamlined tool management thanks to indexable tooling</li> </ul>

### Chatter comparison: AddDoFeed vs. solid endmill



ADD<sup>o</sup>FEED



Competitor Solid endmill

Cutter	: $\varnothing 12$ mm long type, CICT = 2 (Competitor: $\varnothing 12$ mm, CICT = 4)
Overhang length	: 50 mm
Cutting speed	: $V_c = 200$ m/min (Competitor: 120 m/min)
Feed per tooth	: $f_z = 1.2$ mm/t (Competitor: 0.05 mm/t)
Feed speed	: $V_f = 12,740$ mm/min (Competitor: 640 mm/min)
Depth of cut	: $a_p = 0.25$ mm (Competitor: 5 mm)
Width of cut	: $a_e = 12$ mm
Metal removal rate	: $Q = 38$ cm <sup>3</sup> /min

## CUTTING PERFORMANCE

### M SUS304 / X5CrNi18-9 (190HB)

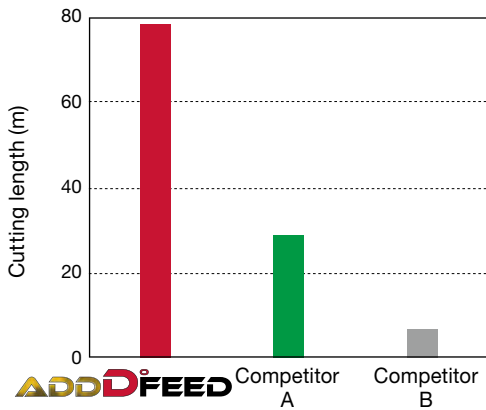

Cutter : EXN02R012M12.0-02 (ø12 mm, CICT = 2)  
 Insert : LNMU0202ZER-MM AH130  
 Tool overhang : 30 mm  
 Cutting speed :  $V_c = 180$  m/min  
 Feed per tooth :  $f_z = 0.3$  mm/t  
 Depth of cut :  $a_p = 0.3$  mm  
 Width of cut :  $a_e = 9.8$  mm  
 Coolant : Wet  
 Machine : Vertical M/C, BT40

### H SKD61 / X40CrMoV5-1 (52HRC)

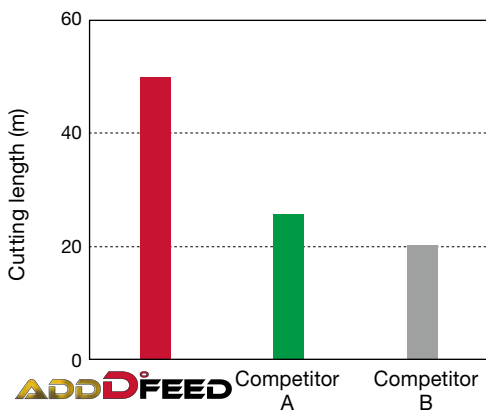

Cutter : EXN02R012M12.0-02 (ø12 mm, CICT = 2)  
 Insert : LNMU0202ZER-MM AH8015  
 Tool overhang : 30 mm  
 Cutting speed :  $V_c = 120$  m/min  
 Feed per tooth :  $f_z = 0.5$  mm/t  
 Depth of cut :  $a_p = 0.3$  mm  
 Width of cut :  $a_e = 9.8$  mm  
 Coolant : Dry  
 Machine : Vertical M/C, BT40

## APPLICATION

### P

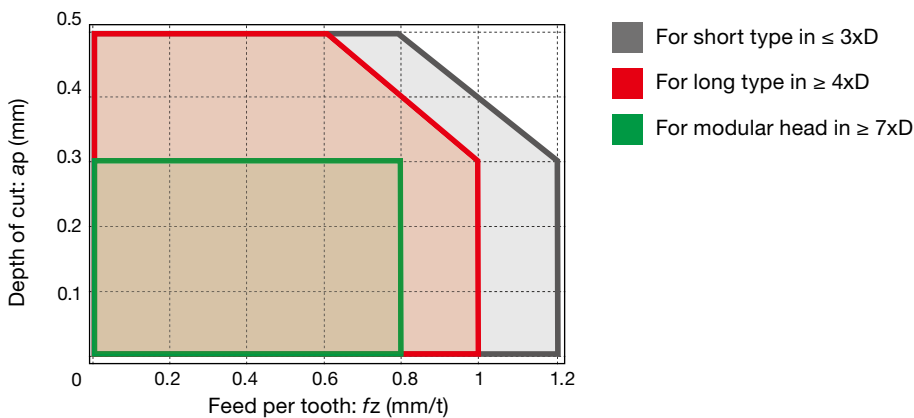

## EXN02

High feed endmill, shank type, for 4-corner double sided inserts

GAMP = +6°, GAMF = +5° ~ +11°

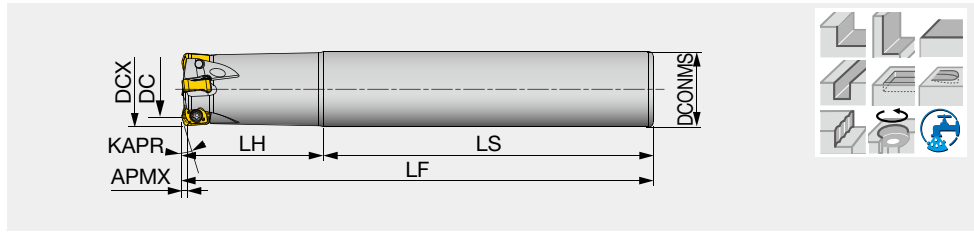

Designation	APMX	DCX	CICT	DC	DCONMS	LF	LH	LS	KAPR	WT(kg)	Air hole	Insert
EXN02R008M08.0-01	0.5	8	1	3.95	8	75	16	59	17°	0.02	With	LNMU02...
EXN02R008M08.0-01L	0.5	8	1	3.95	8	90	31	59	17°	0.03	With	LNMU02...
EXN02R010M10.0-02	0.5	10	2	5.85	10	80	20	60	17°	0.04	With	LNMU02...
EXN02R010M10.0-02L	0.5	10	2	5.85	10	100	40	60	17°	0.05	With	LNMU02...
EXN02R012M12.0-02	0.5	12	2	7.8	12	80	20	60	17°	0.06	With	LNMU02...
EXN02R012M12.0-02L	0.5	12	2	7.8	12	110	50	60	17°	0.08	With	LNMU02...
EXN02R016M16.0-04	0.5	16	4	11.8	16	100	30	70	17°	0.14	With	LNMU02...
EXN02R016M16.0-03L	0.5	16	3	11.8	16	120	50	70	17°	0.17	With	LNMU02...
EXN02R020M20.0-04L	0.5	20	4	15.8	20	160	80	80	17°	0.32	With	LNMU02...
EXN02R020M20.0-05	0.5	20	5	15.8	20	130	50	80	17°	0.27	With	LNMU02...
EXN02R025M25.0-07	0.5	25	7	20.8	25	140	60	80	17°	0.46	With	LNMU02...
EXN02R025M25.0-06L	0.5	25	6	20.8	25	180	100	80	17°	0.57	With	LNMU02...

### SPARE PARTS



Designation	Clamping screw	Wrench
EXN02R008...	CSPB-1.8FL3.6	IP-6DB
EXN02R010...	CSPB-1.8FL4.3	IP-6DB
EXN02R012...	CSPB-1.8FL4.3	IP-6DB
EXN02R016...	CSPB-1.8FL4.3	IP-6DB
EXN02R020...	CSPB-1.8FL4.3	IP-6DB
EXN02R025...	CSPB-1.8FL4.3	IP-6DB

Tool diameter tolerance	
Tool diameter	0 / -0.4

\*Recommended clamping torque (N·m): CSPB-1.8FL3.6, CSPB-1.8FL4.3 = 0.5

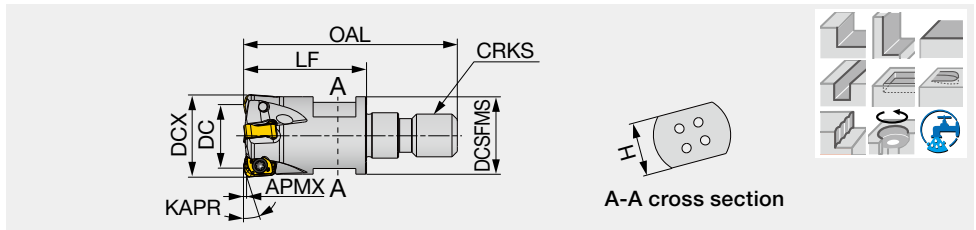

Designation	APMX	DCX	CICT	DC	DCSFMS	OAL	LF	H	KAPR	CRKS	WT(kg)	Air hole	Insert
HXN02R008MM06-01	0.5	8	1	3.95	9.5	33.5	19	7	17°	M6	0.01	With	LNMU02...
HXN02R010MM06-02	0.5	10	2	5.85	9.5	31.5	17	7	17°	M6	0.01	With	LNMU02...
HXN02R012MM06-02	0.5	12	2	7.8	10	31.5	17	7	17°	M6	0.01	With	LNMU02...
HXN02R016MM08-04	0.5	16	4	11.8	14.5	40	23	10	17°	M8	0.03	With	LNMU02...
HXN02R020MM10-05	0.5	20	5	15.8	17.8	49	30	15	17°	M10	0.06	With	LNMU02...
HXN02R025MM12-07	0.5	25	7	20.8	23	52	30	17	17°	M12	0.1	With	LNMU02...

### SPARE PARTS



Designation	Clamping screw	Wrench
HXN02R008...	CSPB-1.8FL3.6	IP-6DB
HXN02R010...	CSPB-1.8FL4.3	IP-6DB
HXN02R012...	CSPB-1.8FL4.3	IP-6DB
HXN02R016...	CSPB-1.8FL4.3	IP-6DB
HXN02R020...	CSPB-1.8FL4.3	IP-6DB
HXN02R025...	CSPB-1.8FL4.3	IP-6DB

Tool diameter tolerance	
Tool diameter	0 / -0.4

\*Recommended clamping torque (N·m): CSPB-1.8FL3.6, CSPB-1.8FL4.3 = 0.5

## INSERT

### LNMU02-MM (for general purpose)

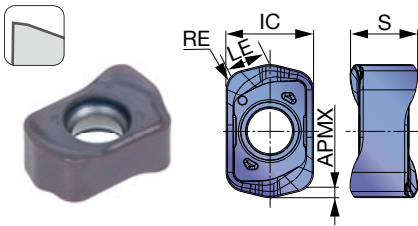

P	Steel	★	☆										
M	Stainless	★	☆										
K	Cast iron		☆	★									
N	Non-ferrous												
S	Superalloy	★		★									
H	Hard materials		☆	★									

★ : First choice  
☆ : Second choice

Designation	RE	APMX	Coated			LE	IC	S
			AH130	AH3225	AH8015			
LNMU0202ZER-MM	0.9	0.5	●	●	●	1.79	4	3.1

● : Line up

## STANDARD CUTTING CONDITIONS

ISO	Workpiece materials	Hardness	Priority	Grades	Cutting speed Vc (m/min)	Feed per tooth fz (mm/t)	
<b>P</b>	Carbon steels S45C, S55C, etc. C45, C55, etc.	- 300HB	First choice	AH3225	100 - 300	0.2 - 1.2	
		- 300HB	For wear resistance	AH8015	100 - 300	0.2 - 1.2	
	Alloy steels SCM440, SCr415, etc. 42CrMo4, etc.	- 300HB	First choice	AH3225	100 - 300	0.2 - 1.2	
		- 300HB	For wear resistance	AH8015	100 - 300	0.2 - 1.2	
	Prehardened steels NAK80, PX5, etc.	30 - 40HRC	First choice	AH8015	100 - 200	0.2 - 0.8	
		30 - 40HRC	For impact resistance	AH3225	100 - 200	0.2 - 0.8	
<b>M</b>	Stainless steels SUS304, SUS316, etc. X5CrNi18-9, X5CrNiMo17-12-2, etc.	- 200HB	First choice	AH130	100 - 150	0.2 - 0.8	
<b>K</b>	Gray cast irons FC250, FC300, etc. 250, 300, etc.	150 - 250HB	First choice	AH8015	100 - 300	0.2 - 1.2	
		150 - 250HB	For impact resistance	AH3225	100 - 300	0.2 - 1.2	
	Ductile cast irons FCD400, etc. 400-15, 600-3, etc.	150 - 250HB	First choice	AH8015	80 - 200	0.2 - 1.2	
		150 - 250HB	For impact resistance	AH3225	80 - 200	0.2 - 1.2	
<b>S</b>	Titanium alloy Ti-6Al-4V, etc.	- 40HRC	First choice	AH130	30 - 60	0.2 - 0.7	
		- 40HRC	For wear resistance	AH8015	30 - 60	0.2 - 0.7	
	Heat-resistant alloy Inconel, Hastelloy, etc.	- 40HRC	First choice	AH8015	20 - 50	0.1 - 0.3	
		- 40HRC	For impact resistance	AH3225	20 - 50	0.1 - 0.3	
<b>H</b>	Hardened steel	SKD61, etc. X40CrMoV5-1, etc.	40 - 50HRC	First choice	AH8015	80 - 150	0.1 - 0.5
			40 - 50HRC	For impact resistance	AH3225	80 - 150	0.1 - 0.5
		SKD11, etc. X153CrMoV12, etc.	50-60HRC	First choice	AH8015	50 - 70	0.1 - 0.3

## APPLICATION RANGE

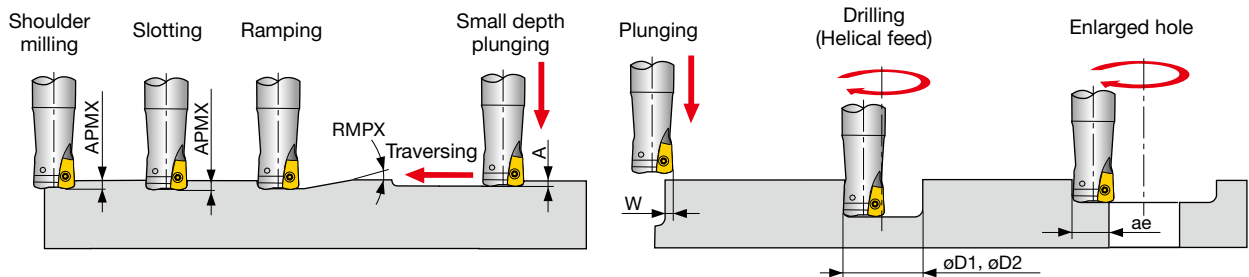

Designation	DCX	Max. depth of cut APMX	Max. ramping angle RMPX	Max. plunging depth A	Max. cutting width in plunging W	Min. machinable hole dia. øD1	Max. machinable hole dia. øD2	Max. cutting width in enlarged hole ae
E/HXN02R008...	8	0.5	0.5	0.03	2	11.5	13.2	5.87
E/HXN02R010...	10	0.5	2.8	0.15	2	13.8	17	7.82
E/HXN02R012...	12	0.5	1.9	0.15	2	17.8	21	9.81
E/HXN02R016...	16	0.5	1.2	0.15	2	25.8	29	13.8
E/HXN02R020...	20	0.5	0.88	0.15	2	33.8	37	17.8
E/HXN02M025...	25	0.5	0.66	0.15	2	43.8	47	22.8

Tool dia.: DCX (mm), Number of revolutions:  $n$  ( $\text{min}^{-1}$ ), Feed speed:  $V_f$  (mm/min), Max. depth of cut:  $a_p = 0.5$  mm, Number of teeth: CICT

$\phi 8$ , CICT = 1		$\phi 10$ , CICT = 2		$\phi 12$ , CICT = 2		$\phi 16$			$\phi 20$			$\phi 25$		
$n$	$V_f$	$n$	$V_f$	$n$	$V_f$	$n$	$V_f$		$n$	$V_f$		$n$	$V_f$	
							CICT = 3	CICT = 4		CICT = 4	CICT = 5		CICT = 6	CICT = 7
7,960	6,370	6,370	10,200	5,310	8,500	3,980	9,560	12,740	3,180	10,180	12,720	2,550	12,240	14,280
$V_c = 200$ m/min, $f_z = 0.8$ mm/t														
7,960	6,370	6,370	10,200	5,310	8,500	3,980	9,560	12,740	3,180	10,180	12,720	2,550	12,240	14,280
$V_c = 200$ m/min, $f_z = 0.8$ mm/t														
5,970	2,990	4,780	4,780	3,980	3,980	2,990	4,490	5,980	2,390	4,780	5,980	1,910	5,730	6,690
$V_c = 150$ m/min, $f_z = 0.5$ mm/t														
4,780	2,390	3,820	3,820	3,190	3,190	2,390	3,590	4,780	1,910	3,820	4,780	1,530	4,590	5,360
$V_c = 120$ m/min, $f_z = 0.5$ mm/t														
7,960	6,370	6,370	10,200	5,310	8,500	3,980	9,560	12,740	3,180	10,180	12,720	2,550	12,240	14,280
$V_c = 200$ m/min, $f_z = 0.8$ mm/t														
5,970	4,780	4,780	7,650	3,980	6,370	2,990	7,180	9,570	2,390	7,650	9,560	1,530	7,350	8,570
$V_c = 150$ m/min, $f_z = 0.8$ mm/t														
1,590	800	1,270	1,270	1,060	1,060	800	1,200	1,600	640	1,280	1,600	510	1,530	1,790
$V_c = 40$ m/min, $f_z = 0.5$ mm/t														
1,190	240	1,000	400	800	320	600	360	480	480	390	480	380	460	540
$V_c = 30$ m/min, $f_z = 0.2$ mm/t														
4,780	1,440	3,820	2,300	3,190	1,920	2,390	2,160	2,870	1,910	2,300	2,870	1,530	2,760	3,220
$V_c = 120$ m/min, $f_z = 0.3$ mm/t														
2,390	480	1,910	770	1,590	640	1,190	720	960	950	760	950	760	920	1,070
$V_c = 60$ m/min, $f_z = 0.2$ mm/t														

## TOOL GEOMETRY ON PROGRAMMING

When programming for CAM, the tool should be considered as a radius cutter. Usually, the corner radius should be set as  $R = 1$  mm. If a larger radius is used, overcutting will occur. The following table shows the amount left uncut ( $t_1$ ) and overcut ( $t_2$ ).

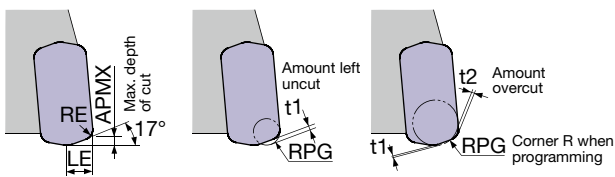

Max. depth of cut APMX (mm)	Corner radius RE (mm)	LE (mm)	Corner R when programming RPG	Amount left uncut $t_1$ (mm)	Amount overcut $t_2$ (mm)
0.5	0.9	2	0.5	0.38	0
0.5	0.9	2	0.8	0.31	0
<b>0.5</b>	<b>0.9</b>	<b>2</b>	<b>1</b>	<b>0.26</b>	<b>0</b>
0.5	0.9	2	1.5	0.14	0.08

\*Recommended

Insert size 03

## Popular DoFeed 03 series now offers UER inserts with small approach angle for higher performance

Two different types of inserts fit the same cutter body

**New**

**LNMU0303UER insert**  
for long tool life and reduced vibration

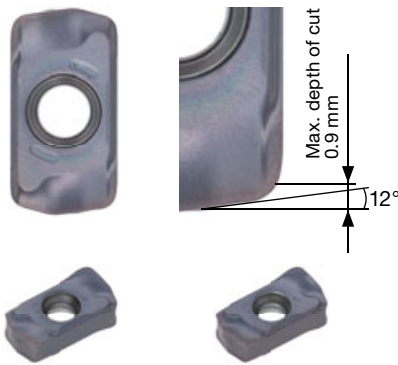

**MJ Chipbreaker**  
- General machining  
- Ideal for machining steel, cast iron, and hardened steel

**ML Chipbreaker**  
- Low cutting force  
- Suitable for machining steel, stainless steel, and difficult-to-cut materials

**LNM/GU0303ZER insert**  
for low cutting forces

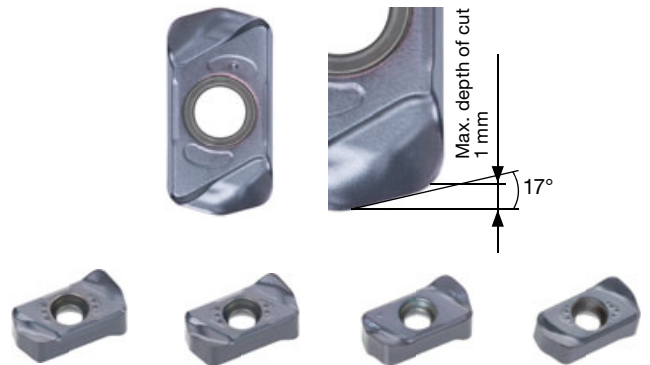

**MJ Chipbreaker**  
General machining

**ML Chipbreaker**  
Low cutting force

**MS Chipbreaker**  
For stainless steel

**MH Chipbreaker**  
Robust cutting edges

UER insert

Approach angle	Benefits	Applications
12°	Extended tool life	Work materials; Hardened steel, stainless steel, and heat-resistant alloys
	Controlled chatter	Machining with long overhang

ZER insert

Approach angle	Benefits	Applications
17°	Low cutting forces	Low rigidity, machines and components
	No chip re-cutting	Pocketing or slotting

### Tool life comparison in SUS630

**M**

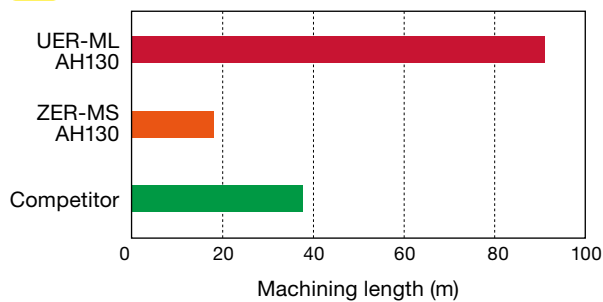

Tool dia. :  $\phi 20$  mm, CICT = 1  
Cutting speed :  $V_c = 150$  m/min

UER inserts create thin chips and extend tool life especially during machining of difficult materials.

### Cutting force comparison in S50C

**P**

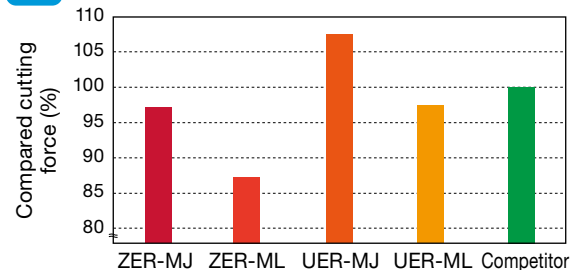

Feed per tooth :  $f_z = 0.8$  mm/t  
Depth of cut :  $a_p = 0.5$  mm

ZER inserts reduce cutting forces by as much as 10% over the competitors.

# CHIPBREAKERS

## MJ General machining

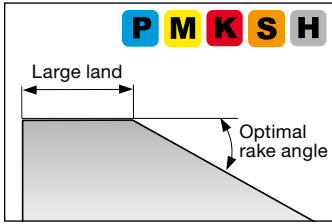

## ML Low cutting force

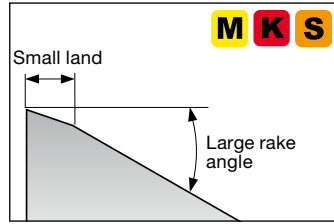

## MS For stainless steel

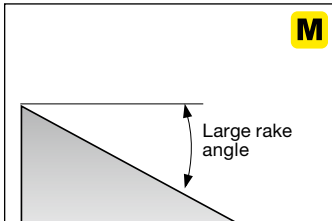

## MH Robust cutting edges

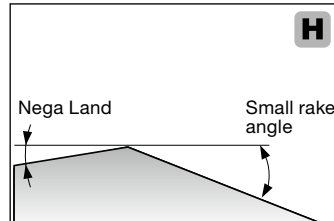

## Chipbreaker characteristics

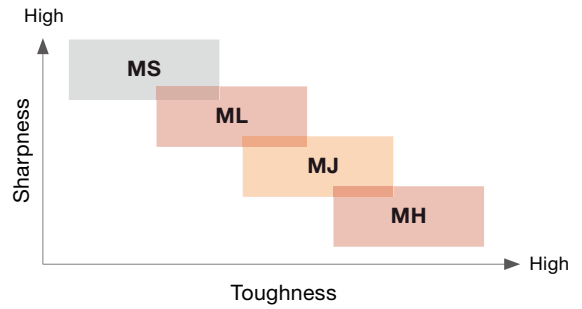

## Available in 3 body types (E/HXN03)

### Premium body / Center-through coolant

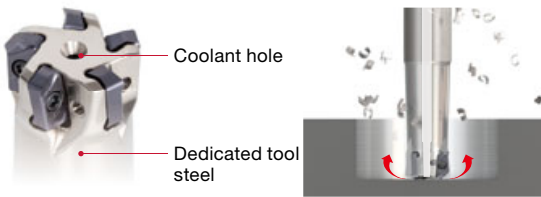

- Effectively evacuates chips
- Most suitable for pocket milling

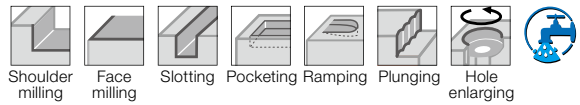

### Premium body / Optimal coolant supply

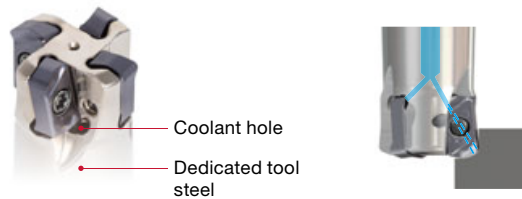

- Coolant goes to the edge directly for effective cooling
- Suitable for the machining of difficult-to-cut materials or small-width cutting

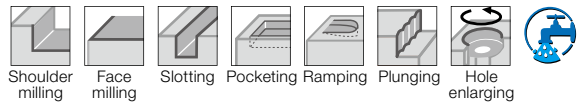

### ECO body

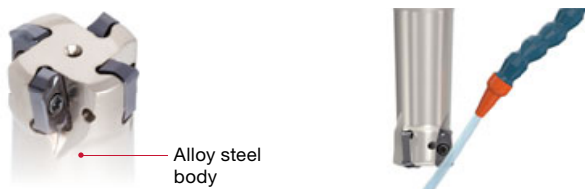

- High-economical bodies due to no coolant-hole

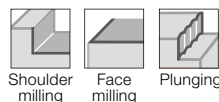

Insert size 03

## TXN03

High feed mill, for 4-corner double sided inserts

GAMP = +6°, GAMF = +12° ~ 13°

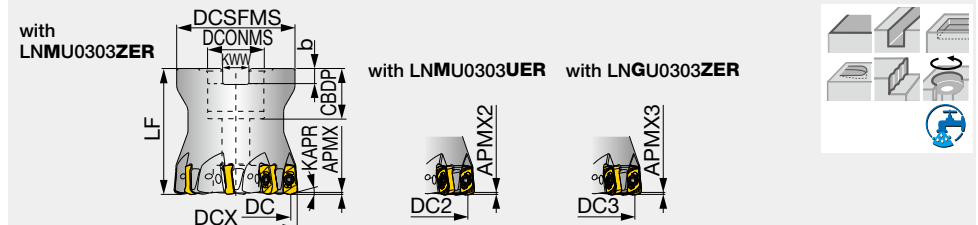

Designation	APMX	APMX2	APMX3	DCX	CICT	DC	DC2	DC3	DCSFMS	DCONMS	CBDP	LF	b	KWW	KAPR	KAPR2*	KAPR3*	WT(kg)	Air hole	Insert
TXN03R040M16.0E05	1	0.9	1	40	5	33.6	32.8	33.7	35	16	18	40	5.6	8.4	17°	12°	17°	0.2	With LN*U03...	
TXN03R040M16.0E06	1	0.9	1	40	6	33.6	32.8	33.7	35	16	18	40	5.6	8.4	17°	12°	17°	0.2	With LN*U03...	
TXN03R050M22.0E05	1	0.9	1	50	5	43.6	42.8	43.7	47	22	20	50	6.3	10.4	17°	12°	17°	0.5	With LN*U03...	
TXN03R050M22.0E08	1	0.9	1	50	8	43.6	42.8	43.7	47	22	20	50	6.3	10.4	17°	12°	17°	0.5	With LN*U03...	
TXN03R050M22.2-08	1	0.9	1	50	8	43.6	42.8	43.7	47	22.225	20	50	5	8	17°	12°	17°	0.5	With LN*U03...	

\*KAPR2 : with LNMU0303UER

\*KAPR3 : with LNGU0303ZER

### SPARE PARTS



Designation	Clamping screw	Lubricant	Shell locking bolt	Wrench
TXN03R04...	CSPB-2.5L080	M-1000	CM8X30H	IP-8D
TXN03R05...	CSPB-2.5L080	M-1000	CM10X30H	IP-8D

#### Tool diameter tolerance

Tool diameter	0 / -0.45
---------------	-----------

\*Recommended clamping torque (N·m): CSPB-2.5L080 = 1.3

## EXN03

High feed endmill, shank type, with center through coolant hole, for 4-corner double sided inserts

GAMP = +6°, GAMF = +5° ~ +11°

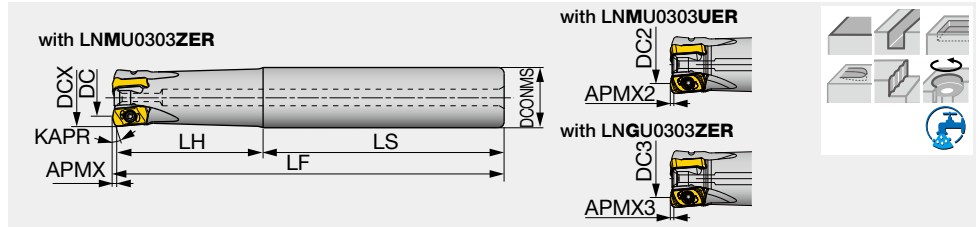

Designation	APMX	APMX2	APMX3	DCX	CICT	DC	DC2	DC3	DCONMS	LF	LH	LS	KAPR	KAPR2	KAPR3*	WT(kg)	Air hole	Insert
EXN03R016M16.0-02 <sup>(1)</sup>	1	0.9	1	16	2	9.6	8.8	9.8	16	100	30	70	15°	10°	15°	0.2	With	LN*U03...
EXN03R016M16.0-02L <sup>(1)</sup>	1	0.9	1	16	2	9.6	8.8	9.8	16	150	50	100	15°	10°	15°	0.2	With	LN*U03...
EXN03R018M16.0-02 <sup>(1)</sup>	1	0.9	1	18	2	11.5	10.7	11.7	16	100	30	70	17°	12°	17°	0.2	With	LN*U03...
EXN03R018M16.0-02L <sup>(1)</sup>	1	0.9	1	18	2	11.5	10.7	11.7	16	150	25	125	17°	12°	17°	0.2	With	LN*U03...
EXN03R020M20.0-03 <sup>(2)</sup>	1	0.9	1	20	3	13.5	12.7	13.6	20	130	50	80	17°	12°	17°	0.3	With	LN*U03...
EXN03R020M20.0-03L <sup>(2)</sup>	1	0.9	1	20	3	13.5	12.7	13.6	20	160	80	80	17°	12°	17°	0.3	With	LN*U03...
EXN03R020M20.0-04 <sup>(1)</sup>	1	0.9	1	20	4	13.5	12.7	13.6	20	130	50	80	17°	12°	17°	0.3	With	LN*U03...
EXN03R022M20.0-03 <sup>(2)</sup>	1	0.9	1	22	3	15.5	14.7	15.6	20	130	50	80	17°	12°	17°	0.3	With	LN*U03...
EXN03R022M20.0-03L <sup>(2)</sup>	1	0.9	1	22	3	15.5	14.7	15.6	20	160	30	130	17°	12°	17°	0.4	With	LN*U03...
EXN03R022M20.0-04 <sup>(1)</sup>	1	0.9	1	22	4	15.5	14.7	15.6	20	130	50	80	17°	12°	17°	0.3	With	LN*U03...
EXN03R025M25.0-04 <sup>(2)</sup>	1	0.9	1	25	4	18.5	17.7	18.6	25	140	60	80	17°	12°	17°	0.5	With	LN*U03...
EXN03R025M25.0-04L <sup>(2)</sup>	1	0.9	1	25	4	18.5	17.7	18.6	25	180	100	80	17°	12°	17°	0.6	With	LN*U03...
EXN03R025M25.0-05 <sup>(1)</sup>	1	0.9	1	25	5	18.5	17.7	18.6	25	140	60	80	17°	12°	17°	0.5	With	LN*U03...
EXN03R028M25.0-04 <sup>(2)</sup>	1	0.9	1	28	4	21.5	20.7	21.6	25	140	60	80	17°	12°	17°	0.5	With	LN*U03...
EXN03R028M25.0-04L <sup>(2)</sup>	1	0.9	1	28	4	21.5	20.7	21.6	25	180	35	145	17°	12°	17°	0.7	With	LN*U03...
EXN03R028M25.0-05 <sup>(2)</sup>	1	0.9	1	28	5	21.5	20.7	21.6	25	140	60	80	17°	12°	17°	0.5	With	LN*U03...
EXN03R030M32.0-04 <sup>(2)</sup>	1	0.9	1	30	4	23.5	22.7	23.6	32	150	70	80	17°	12°	17°	0.8	With	LN*U03...
EXN03R030M32.0-04L <sup>(2)</sup>	1	0.9	1	30	4	23.5	22.7	23.6	32	200	120	80	17°	12°	17°	0.9	With	LN*U03...
EXN03R030M32.0-05 <sup>(2)</sup>	1	0.9	1	30	5	23.5	22.7	23.6	32	150	70	80	17°	12°	17°	0.8	With	LN*U03...
EXN03R032M32.0-05 <sup>(2)</sup>	1	0.9	1	32	5	25.5	24.7	25.6	32	150	70	80	17°	12°	17°	0.8	With	LN*U03...
EXN03R032M32.0-05L <sup>(2)</sup>	1	0.9	1	32	5	25.5	24.7	25.6	32	200	120	80	17°	12°	17°	1.1	With	LN*U03...
EXN03R032M32.0-06 <sup>(1)</sup>	1	0.9	1	32	6	25.5	24.7	25.6	32	150	70	80	17°	12°	17°	0.9	With	LN*U03...
EXN03R035M32.0-05 <sup>(2)</sup>	1	0.9	1	35	5	28.5	27.7	28.6	32	150	35	115	17°	12°	17°	0.9	With	LN*U03...
EXN03R035M32.0-05L <sup>(2)</sup>	1	0.9	1	35	5	28.5	27.7	28.6	32	200	35	165	17°	12°	17°	1.2	With	LN*U03...
EXN03R035M32.0-06 <sup>(2)</sup>	1	0.9	1	35	6	28.5	27.7	28.6	32	150	35	115	17°	12°	17°	0.9	With	LN*U03...

\*KAPR2 : with LNMU0303UER

\*KAPR3 : with LNMU0303ZER

Clamping screws used for (1) and (2) above are different. See below for the part codes.

### SPARE PARTS



Designation	Clamping screw	Lubricant	Wrench	Tool diameter tolerance	
EXN03...	(1) CSPB-2.5 (2) CSPB-2.5L080	M-1000	IP-8D	Tool diameter	0 / -0.45

\*Recommended clamping torque (N·m): CSPB-2.5/CSPB-2.5L080 = 1.3

## Insert size 03

### EXN03-C

High feed endmill, shank type, with coolant directly to the tool tips, for 4-corner double sided inserts

GAMP = +6°, GAMF = +5° ~ +11°

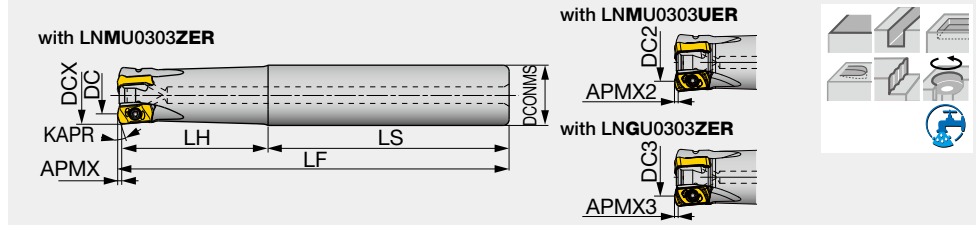

Designation	APMX	APMX2	APMX3	DCX	CICT	DC	DC2	DC3	DCONMS	LF	LH	LS	KAPR	KAPR2*	KAPR3*	WT(kg)	Air hole	Insert
EXN03R016M16.0-02-C <sup>(1)</sup>	1	0.9	1	16	2	9.6	8.8	9.8	16	100	30	70	15°	10°	15°	0.2	With LN*U03...	
EXN03R016M16.0-02L-C <sup>(1)</sup>	1	0.9	1	16	2	9.6	8.8	9.8	16	150	50	100	15°	10°	15°	0.2	With LN*U03...	
EXN03R020M20.0-03-C <sup>(2)</sup>	1	0.9	1	20	3	13.5	12.7	13.6	20	130	50	80	17°	12°	17°	0.3	With LN*U03...	
EXN03R020M20.0-03L-C <sup>(2)</sup>	1	0.9	1	20	3	13.5	12.7	13.6	20	160	80	80	17°	12°	17°	0.3	With LN*U03...	
EXN03R020M20.0-04-C <sup>(1)</sup>	1	0.9	1	20	4	13.5	12.7	13.6	20	130	50	80	17°	12°	17°	0.3	With LN*U03...	
EXN03R025M25.0-04-C <sup>(2)</sup>	1	0.9	1	25	4	18.5	17.7	18.6	25	140	60	80	17°	12°	17°	0.5	With LN*U03...	
EXN03R025M25.0-04L-C <sup>(2)</sup>	1	0.9	1	25	4	18.5	17.7	18.6	25	180	100	80	17°	12°	17°	0.6	With LN*U03...	
EXN03R025M25.0-05-C <sup>(1)</sup>	1	0.9	1	25	5	18.5	17.7	18.6	25	140	60	80	17°	12°	17°	0.5	With LN*U03...	
EXN03R032M32.0-05-C <sup>(2)</sup>	1	0.9	1	32	5	25.5	24.7	25.6	32	150	70	80	17°	12°	17°	0.8	With LN*U03...	
EXN03R032M32.0-05L-C <sup>(2)</sup>	1	0.9	1	32	5	25.5	24.7	25.6	32	200	120	80	17°	12°	17°	1.1	With LN*U03...	
EXN03R032M32.0-06-C <sup>(1)</sup>	1	0.9	1	32	6	25.5	24.7	25.6	32	150	70	80	17°	12°	17°	0.8	With LN*U03...	
EXN03R040M32.0-06-C <sup>(2)</sup>	1	0.9	1	40	6	33.6	32.8	33.7	32	150	45	105	17°	12°	17°	1	With LN*U03...	
EXN03R040M32.0-06L-C <sup>(2)</sup>	1	0.9	1	40	6	33.6	32.8	33.7	32	220	45	175	17°	12°	17°	1.4	With LN*U03...	

\*KAPR2 : with LNMU0303UER

\*KAPR3 : with Lngu0303ZER

Clamping screws used for (1) and (2) above are different. See below for the part codes.

#### SPARE PARTS



Designation	Clamping screw	Lubricant	Wrench	Tool diameter tolerance	
EXN03...	(1) CSPB-2.5 (2) CSPB-2.5L080	M-1000	IP-8D	Tool diameter	0 / -0.45

\*Recommended clamping torque (N·m): CSPB-2.5/CSPB-2.5L080 = 1.3

### EXN03-N

High feed endmill (Eco), shank type, for double sided inserts

GAMP = +6°, GAMF = +5° ~ +11°

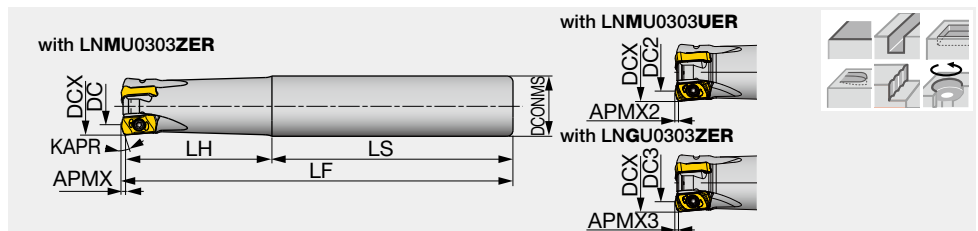

Designation	APMX	APMX2	APMX3	DCX	CICT	DC	DC2	DC3	DCONMS	LF	LH	LS	KAPR	KAPR2*	KAPR3*	WT(kg)	Air hole	Insert
EXN03R016M16.0-02N <sup>(1)</sup>	1	0.9	1	16	2	9.6	8.8	9.8	16	100	30	70	15°	10°	15°	0.2	Without LN*U03...	
EXN03R020M20.0-03N <sup>(2)</sup>	1	0.9	1	20	3	13.5	12.7	13.6	20	130	50	80	17°	12°	17°	0.3	Without LN*U03...	
EXN03R025M25.0-04N <sup>(2)</sup>	1	0.9	1	25	4	18.5	17.7	18.6	25	140	60	80	17°	12°	17°	0.5	Without LN*U03...	
EXN03R032M32.0-05N <sup>(2)</sup>	1	0.9	1	32	5	25.5	24.7	25.6	32	150	70	80	17°	12°	17°	0.8	Without LN*U03...	

\*KAPR2 : with LNMU0303UER

\*KAPR3 : with Lngu0303ZER

Clamping screws used for (1) and (2) above are different. See below for the part codes.

#### SPARE PARTS



Designation	Clamping screw	Lubricant	Wrench	Tool diameter tolerance	
EXN03...	(1) CSPB-2.5 (2) CSPB-2.5L080	M-1000	IP-8D	Tool diameter	0 / -0.45

\*Recommended clamping torque (N·m): CSPB-2.5/CSPB-2.5L080 = 1.3

## HXN03

High feed endmill, modular type (TungFlex)

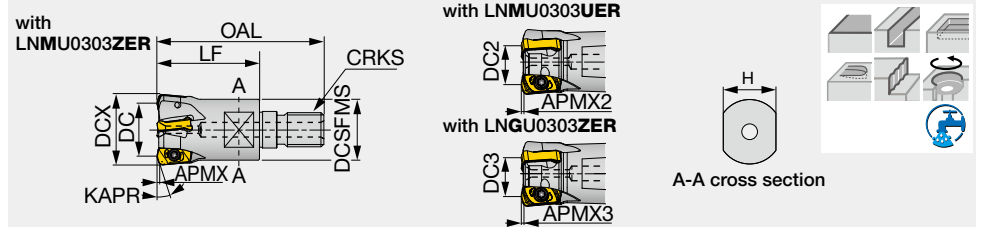

GAMP= +6°, GAMF= +5° ~ +11°

Designation	APMX	APMX2	APMX3	DCX	CICT	DC	DC2	DC3	OAL	LF	H	DCSFMS	KAPR	KAPR2*	KAPR3*	CRKS	WT(kg)	Air hole	Insert
HXN03R016MM08-02 <sup>(1)</sup>	1	0.9	1	16	2	9.6	8.8	9.8	42	25	10	12.8	15°	10°	15°	M8	0.03	With	LN*U03...
HXN03R018MM08-02 <sup>(1)</sup>	1	0.9	1	18	2	11.5	10.7	11.7	42	25	10	14.5	17°	12°	17°	M8	0.04	With	LN*U03...
HXN03R020MM10-03 <sup>(2)</sup>	1	0.9	1	20	3	13.5	12.7	13.6	49	30	15	17.8	17°	12°	17°	M10	0.06	With	LN*U03...
HXN03R020MM10-04 <sup>(1)</sup>	1	0.9	1	20	4	13.5	12.7	13.6	49	30	15	17.8	17°	12°	17°	M10	0.06	With	LN*U03...
HXN03R022MM10-03 <sup>(2)</sup>	1	0.9	1	22	3	15.5	14.7	15.6	49	30	15	17.8	17°	12°	17°	M10	0.06	With	LN*U03...
HXN03R022MM10-04 <sup>(1)</sup>	1	0.9	1	22	4	15.5	14.7	15.6	49	30	15	17.8	17°	12°	17°	M10	0.07	With	LN*U03...
HXN03R025MM12-04 <sup>(2)</sup>	1	0.9	1	25	4	18.5	17.7	18.6	57	35	17	20.8	17°	12°	17°	M12	0.1	With	LN*U03...
HXN03R025MM12-05 <sup>(1)</sup>	1	0.9	1	25	5	18.5	17.7	18.6	57	35	17	20.8	17°	12°	17°	M12	0.11	With	LN*U03...
HXN03R028MM12-04 <sup>(2)</sup>	1	0.9	1	28	4	21.5	20.7	21.6	57	35	17	23	17°	12°	17°	M12	0.12	With	LN*U03...
HXN03R028MM12-05 <sup>(2)</sup>	1	0.9	1	28	5	21.5	20.7	21.6	57	35	17	23	17°	12°	17°	M12	0.12	With	LN*U03...
HXN03R030MM16-04 <sup>(2)</sup>	1	0.9	1	30	4	23.5	22.7	23.6	63	40	22	28.8	17°	12°	17°	M16	0.19	With	LN*U03...
HXN03R030MM16-05 <sup>(2)</sup>	1	0.9	1	30	5	23.5	22.7	23.6	63	40	22	28.8	17°	12°	17°	M16	0.2	With	LN*U03...
HXN03R032MM16-05 <sup>(2)</sup>	1	0.9	1	32	5	25.5	24.7	25.6	63	40	22	28.8	17°	12°	17°	M16	0.2	With	LN*U03...
HXN03R032MM16-06 <sup>(1)</sup>	1	0.9	1	32	6	25.5	24.7	25.6	63	40	22	28.8	17°	12°	17°	M16	0.21	With	LN*U03...

\*KAPR2 : with LNMU0303UER

\*KAPR3 : with Lngu0303ZER

Clamping screws used for (1) and (2) above are different. See below for the part codes.

### SPARE PARTS



Designation	Clamping screw	Lubricant	Wrench	Tool diameter tolerance	
HXN03...	(1) CSPB-2.5 (2) CSPB-2.5L080	M-1000	IP-8D	Tool diameter	0 / -0.45

\*Recommended clamping torque (N·m): CSPB-2.5/CSPB-2.5L080 = 1.3

Insert size 03

## HXN03-C

High feed endmill, modular type, with coolant directly to the tool tips (TungFlex)

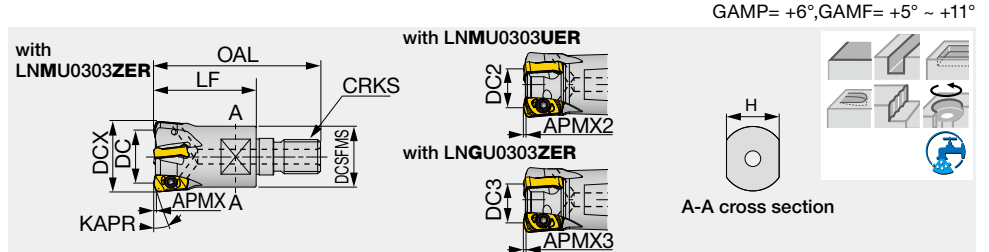

Designation	APMX	APMX2	APMX3	DCX	CICT	DC	DC2	DC3	OAL	LF	H	DCSFMS	KAPR	KAPR2*	KAPR3*	CRKS	WT(kg)	Air hole	Insert
HXN03R016MM08-02-C <sup>(1)</sup>	1	0.9	1	16	2	9.6	8.8	9.8	42	25	10	12.8	15°	10°	15°	M8	0.03	With	LN*U03...
HXN03R020MM10-03-C <sup>(2)</sup>	1	0.9	1	20	3	13.5	12.7	13.6	49	30	15	17.8	17°	12°	17°	M10	0.06	With	LN*U03...
HXN03R020MM10-04-C <sup>(1)</sup>	1	0.9	1	20	4	13.5	12.7	13.6	49	30	15	17.8	17°	12°	17°	M10	0.06	With	LN*U03...
HXN03R025MM12-04-C <sup>(2)</sup>	1	0.9	1	25	4	18.5	17.7	18.6	57	35	17	20.8	17°	12°	17°	M12	0.1	With	LN*U03...
HXN03R025MM12-05-C <sup>(1)</sup>	1	0.9	1	25	5	18.5	17.7	18.6	57	35	17	20.8	17°	12°	17°	M12	0.1	With	LN*U03...
HXN03R032MM16-05-C <sup>(2)</sup>	1	0.9	1	32	5	25.5	24.7	25.6	63	40	22	28.8	17°	12°	17°	M16	0.2	With	LN*U03...
HXN03R032MM16-06-C <sup>(1)</sup>	1	0.9	1	32	6	25.5	24.7	25.6	63	40	22	28.8	17°	12°	17°	M16	0.2	With	LN*U03...
HXN03R040MM16-06-C <sup>(2)</sup>	1	0.9	1	40	6	33.6	32.8	33.7	63	40	22	28.8	17°	12°	17°	M16	0.27	With	LN*U03...

\*KAPR2 : with LNMU0303UER

\*KAPR3 : with Lngu0303ZER

Clamping screws used for (1) and (2) above are different. See below for the part codes.

### SPARE PARTS



Designation	Clamping screw	Lubricant	Wrench	Tool diameter tolerance	
HXN03...	(1) CSPB-2.5 (2) CSPB-2.5L080	M-1000	IP-8D	Tool diameter	0 / -0.45

\*Recommended clamping torque (N·m): CSPB-2.5/CSPB-2.5L080 = 1.3

# INSERT

**LNMU03ZER-MJ** (for general purpose)

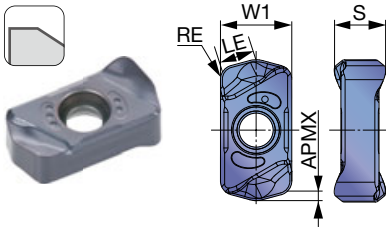

**LNMU03ZER-ML** (for low cutting force)

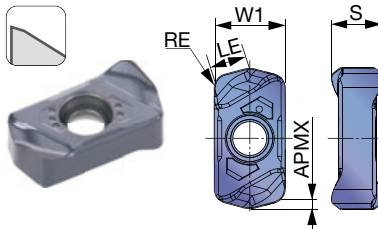

**LNMU03ZER-MS** (for stainless steel)

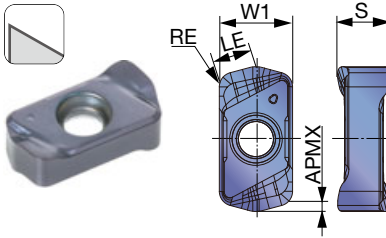

**LNGU03ZER-MH** (Robust cutting edges)

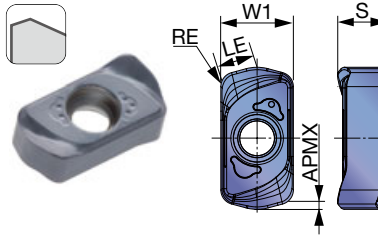

**LNMU03UER-MJ** (for general purpose, low approach angle)

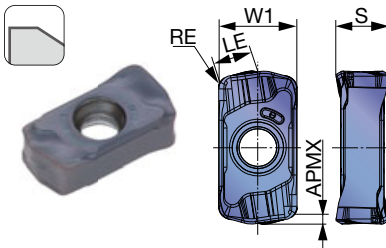

**LNMU03UER-ML** (for low cutting force, low approach angle)

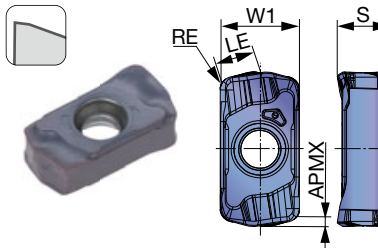

P	Steel		★																		
M	Stainless	★	☆																		
K	Cast iron		☆	★	☆																
N	Non-ferrous																				
S	Titanium	★	☆																		
S	Inconel			☆			★														
H	Hard materials			☆			★	☆													

★ : First choice  
☆ : Second choice

Designation	RE	APMX	Coated						LE	W1	S
			AH130	AH3225	AH725	AH120	AH8015	AH8005			
LNMU0303ZER-MJ	1.2	1	●	●	●	●	●		3.2	6	4.3
LNMU0303ZER-ML	1.2	1	●	●	●		●		3.2	6	4.3
LNMU0303ZER-MS	1.2	1	●	●					3.2	6	4.3
LNGU0303ZER-MH	1.2	1					●	●	3.2	6	4.3
LNMU0303UER-MJ	1	0.9	●	●			●		3.1	6	4.1
LNMU0303UER-ML	1	0.9	●	●			●		3.1	6	4.1

● : New product  
● : Line up

Insert size 03

## STANDARD CUTTING CONDITIONS

ZER type

ISO	Workpiece materials	Hardness	Priority	Grade	Chip-breaker	Cutting speed Vc (m/min)	Feed per tooth: fz (mm/t)										
							Tool dia.: DCX (mm)			Plunging		ø16, CICT = 2		ø18, CICT = 2		ø20	
							ø16	ø22	ø25 - ø50	n	Vf	n	Vf	n	Vf		
										CICT = 3		CICT = 4					
P	Carbon steels S45C, S55C, etc. C45, C55, etc.	- 300HB	First choice	AH3225	MJ	100 - 300	0.5 - 1.2	0.5 - 1.5	0.1	3,980	6,370	3,540	5,660	3,180	7,630	10,180	
	Alloy steels SCM440, SCr415, etc.	- 300HB	First choice	AH3225	MJ	100 - 300	0.5 - 1.2	0.5 - 1.5	0.1	3,980	6,370	3,540	5,660	3,180	7,630	10,180	
	Prehardened steels NAK80, PX5, etc.	30-40HRC	First choice	AH3225	MJ	100 - 200	0.5 - 1.0	0.5 - 1.0	0.1	2,980	4,170	2,650	3,710	2,390	5,020	6,690	
		30-40HRC	for wear resistance	AH8015	MJ	100 - 200	0.5 - 1.0	0.5 - 1.0	0.1	2,980	4,170	2,650	3,710	2,390	5,020	6,690	
M	Stainless steels SUS304, X5CrNi18-9, etc.	- 200HB	First choice	AH130	MS	80 - 150	0.3 - 0.8	0.3 - 0.8	0.1	2,390	2,390	2,120	2,120	1,910	2,860	3,820	
	Precipitation hardening stainless steels SUS630, X5CrNiCuNb16-4, etc.	28HRC - (H1150)	First choice	AH130	MS	80 - 150	0.2 - 0.5	0.2 - 0.5	0.1	2,390	1,430	2,120	1,270	1,910	1,720	2,290	
		40HRC - (H900)	First choice	AH3225	ML	80 - 120	0.1 - 0.3	0.1 - 0.3	0.1	1,990	800	1,770	710	1,590	950	1,270	
				for impact resistance	AH3225	MJ											
K	Gray cast irons FC250, GG25, 250, etc.	150-250HB	First choice	AH725	MJ	100 - 300	0.5 - 1.2	0.5 - 1.5	0.1	3,980	6,370	3,540	5,660	3,180	7,630	10,180	
	Ductile cast irons FCD400, etc.	150-250HB	First choice	AH725	MJ	80 - 200	0.5 - 1.2	0.5 - 1.5	0.1	2,980	4,770	2,650	4,240	2,390	5,740	7,650	
S	Titanium alloy Ti-6Al-4V, etc.	- 40HRC	First choice	AH130	ML	30 - 60	0.3 - 0.7	0.3 - 0.7	0.08	800	640	710	570	640	770	1,020	
			for impact resistance	AH130	MJ												
	Heat-resistant alloy Inconel, Hastelloy, etc.	- 40HRC	First choice	AH8015	ML	20 - 50	0.1 - 0.3	0.1 - 0.3	0.05	600	240	530	210	480	290	380	
			for impact resistance	AH725	ML												
H	Hot mold steel SKD61, X40CrMoV5-1, etc.	40-55HRC	First choice	AH8015	MH	80 - 150	0.1 - 0.5	0.1 - 0.5	0.05	2,390	1,430	2,120	1,270	1,910	1,720	2,290	
			Low resistance	AH8015	MJ		0.1 - 0.3	0.1 - 0.3									
	Hot mold steel of D.T.C materials DAC**, DH**, DIEVER, etc.	40-55HRC	First choice	AH8015	MJ	50-100	0.1 - 0.3	0.1 - 0.3	0.05	1,590	640	1,420	570	1,270	760	1,020	
			for impact resistance	AH8015	MH		0.1 - 0.5	0.1 - 0.5									
Cold mold steels SKD11, X153CrMoV12, etc.	55-60HRC	First choice	AH8005	MH	50 - 70	0.05 - 0.2	0.03 - 0.1	0.03	1,190	290	1,060	250	950	340	450		
		for impact resistance	AH8015	MH	50 - 70	0.05 - 0.1	0.05 - 0.2	0.03	1,190	150	1,060	130	950	170	230		

- When chips stay in the cutting zone during slotting or pocketing, use air blast to remove chips from the work area

- Tool overhang length must be as short as possible to avoid chatter. When the tool overhang length is long, decrease the number of revolutions and feed

## APPLICATION RANGE

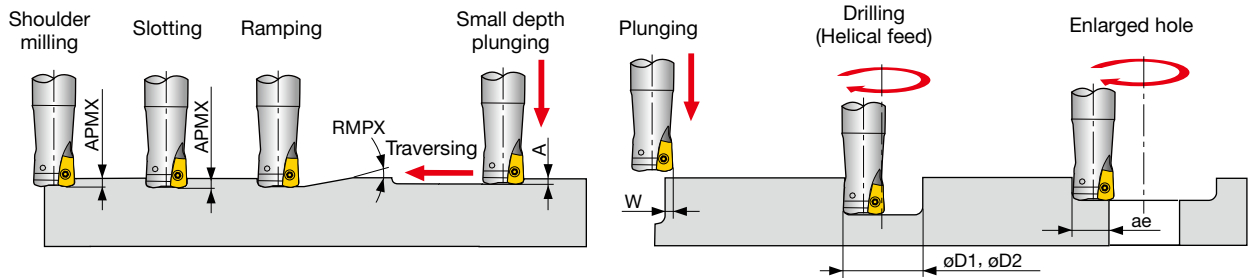

Designation	DCX	Max. depth of cut APMX	Max. ramping angle RMPX		Max. plunging depth A	Max. cutting width in plunging W		Min. machinable hole dia. øD1	Max. machinable hole dia. øD2	Max. cutting width in enlarged hole ae	
			MJ/ML/MS	MH		MJ/ML/MS	MH				
			øD1			øD2					
E/HXN03R016M...	16	1	2.1	1.7	0.3	3.5	3	22	23	30	12.5
E/HXN03R018M...	18	1	1.7	1.6	0.3	3.5	3	26	27	34	14.5
E/HXN03R020M...	20	1	1.4	1.3	0.3	3.5	3	30	31	38	16.5
E/HXN03R022M...	22	1	1.2	1.1	0.3	3.5	3	34	35	42	18.5
E/HXN03R025M...	25	1	1.0	0.9	0.3	3.5	3	40	41	48	21.5
E/HXN03R028M...	28	1	0.8	0.8	0.3	3.5	3	46	46	54	24.5
E/HXN03R030M...	30	1	0.7	0.7	0.3	3.5	3	50	50	58	26.5
E/HXN03R032M...	32	1	0.7	0.7	0.3	3.5	3	54	54	62	28.5
EXN03R035M...	35	1	0.6	0.6	0.3	3.5	3	60	60	68	31.5
E/H/TXN03R040M...	40	1	0.5	0.5	0.3	3.5	3	70	70	78	36.5
TXN03R050M...	50	1	0.4	0.4	0.3	3.5	3	90	90	98	46.5

Note: For DCX above ø33 mm, slot milling, ramping or contouring is not recommended as chips may be re-cut

**Tool dia.: DCX (mm), Number of revolutions:  $n$  (min<sup>-1</sup>), Feed speed:  $V_f$  (mm/min), Max. depth of cut:  $a_p = 1$  mm, Number of teeth: CICT**

ø22			ø25			ø28			ø30			ø32			ø35			ø40			ø50		
$n$	$V_f$		$n$	$V_f$		$n$	$V_f$		$n$	$V_f$		$n$	$V_f$		$n$	$V_f$		$n$	$V_f$		$n$	$V_f$	
	CICT=3	CICT=4		CICT=4	CICT=5		CICT=4	CICT=5		CICT=4	CICT=5		CICT=5	CICT=6		CICT=5	CICT=6		CICT=5	CICT=6		CICT=5	CICT=6
2,890	6,940	9,250	2,550	8,160	10,180	2,270	7,280	9,100	2,120	8,480	10,600	1,990	9,950	11,940	1,820	9,100	10,920	1,590	7,950	9,540	1,270	6,350	10,160
$V_c = 200$ m/min, $f_z = 1.0$ mm/t																							
2,890	6,940	9,250	2,550	8,160	10,180	2,270	7,280	9,100	2,120	8,480	10,600	1,990	9,950	11,940	1,820	9,100	10,920	1,590	7,950	9,540	1,270	6,350	10,160
$V_c = 200$ m/min, $f_z = 1.0$ mm/t																							
2,170	4,560	6,080	1,910	5,350	6,690	1,710	4,790	5,990	1,590	4,450	5,570	1,490	5,220	6,260	1,360	4,760	5,710	1,190	4,170	5,000	950	3,330	5,320
$V_c = 150$ m/min, $f_z = 0.7$ mm/t																							
2,170	4,560	6,080	1,910	5,350	6,690	1,710	4,790	5,990	1,590	4,450	5,570	1,490	5,220	6,260	1,360	4,760	5,710	1,190	4,170	5,000	950	3,330	5,320
$V_c = 150$ m/min, $f_z = 0.7$ mm/t																							
3,180	4,770	6,360	1,530	3,060	3,820	1,360	2,720	3,400	1,270	2,540	3,180	1,190	2,980	3,570	1,090	2,720	3,270	960	2,400	2,880	760	1,900	2,280
$V_c = 120$ m/min, $f_z = 0.5$ mm/t																							
1,740	1,570	2,090	1,530	1,840	2,300	1,370	1,640	2,060	1,270	1,520	1,910	1,190	1,790	2,140	1,090	1,640	1,960	960	1,440	1,730	760	1,140	1,820
$V_c = 120$ m/min, $f_z = 0.3$ mm/t																							
1,450	870	1,160	1,270	1,020	1,270	1,140	910	1,140	1,060	850	1,060	1,000	1,000	1,200	910	910	1,090	800	800	960	640	640	1,020
$V_c = 100$ m/min, $f_z = 0.2$ mm/t																							
2,890	6,940	9,250	2,550	8,160	10,180	2,270	7,280	9,100	2,120	8,480	10,600	1,990	9,950	11,940	1,820	9,100	10,920	1,590	7,950	9,540	1,270	6,350	10,160
$V_c = 200$ m/min, $f_z = 1.0$ mm/t																							
2,170	5,210	6,940	1,910	6,110	7,640	1,710	5,460	6,820	1,590	6,360	7,950	1,490	7,450	8,940	1,360	6,800	8,160	1,190	5,950	7,140	950	4,750	5,700
$V_c = 150$ m/min, $f_z = 1.0$ mm/t																							
580	700	930	510	820	1,020	450	730	910	420	840	1,050	400	1,000	1,200	360	900	1,080	320	800	960	250	630	1,000
$V_c = 40$ m/min, $f_z = 0.5$ mm/t																							
430	260	340	380	230	290	340	200	260	320	260	320	300	300	360	270	270	320	240	240	290	190	190	300
$V_c = 30$ m/min, $f_z = 0.2$ mm/t																							
1,740	1,570	2,090	1,530	1,840	2,300	1,360	1,630	2,040	1,270	1,520	1,910	1,190	1,790	2,140	1,090	1,640	1,960	950	1,430	1,710	760	1,140	1,820
$V_c = 120$ m/min, $f_z = 0.3$ mm/t																							
1,160	700	930	1,020	820	1,020	910	730	910	850	680	850	800	800	960	730	730	880	640	640	770	510	510	820
$V_c = 80$ m/min, $f_z = 0.2$ mm/t																							
870	310	420	760	300	380	680	270	340	640	260	320	600	300	360	550	230	340	480	240	280	380	200	300
$V_c = 60$ m/min, $f_z = 0.1$ mm/t																							
870	160	210	760	150	190	680	140	170	640	130	160	600	150	180	550	120	170	480	120	140	380	100	150
$V_c = 60$ m/min, $f_z = 0.06$ mm/t																							

- The above table shows the conditions for standard shank type cutters. When using long shank type cutters, the number of teeth may be different.  
 - Cutting conditions are generally limited by the rigidity and power of the machine and the rigidity

of the workpiece. When setting the conditions, start from half of the values of the standard cutting conditions and then increase the value gradually while making sure the machine is running normally

## TOOL GEOMETRY ON PROGRAMMING

When programming for CAM, the tool should be considered as a radius cutter. Usually, the corner radius should be set as  $R = 1.5$  mm. If a larger radius is used, overcutting will occur. The following table shows the amount left uncut ( $t_1$ ) and overcut ( $t_2$ ).

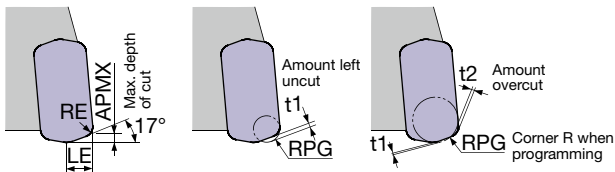

LNMU0303ZER...

Max. depth of cut APMX (mm)	Corner radius RE (mm)	LE (mm)	Corner R when programming RPG	Amount left uncut $t_1$ (mm)	Amount overcut $t_2$ (mm)
1	1.2	3	1	0.6	-
1	1.2	3	1.5	0.5	-
1	1.2	3	2	0.25	0.08
1	1.2	3	2.5	0.14	0.26

LNGU0303ZER...

Max. depth of cut APMX (mm)	Corner radius RE (mm)	LE (mm)	Corner R when programming RPG	Amount left uncut $t_1$ (mm)	Amount overcut $t_2$ (mm)
1	1.2	3	1	0.45	-
1	1.2	3	1.5	0.35	-
1	1.2	3	2	0.2	0.1
1	1.2	3	2.5	0.08	0.29

Note: Each value in table is calculated theoretically at the maximum condition

Insert size 03

## STANDARD CUTTING CONDITIONS

UER type

ISO	Workpiece material	Hardness	Priority	Grade	Chip-breaker	Cutting speed Vc (m/min)	Feed per tooth: fz (mm/t)			ø16, CICT = 2		ø18, CICT = 2		ø20			
							Tool dia.: DCX (mm)			Plunging	n	Vf	n	Vf	n	Vf	
							ø16 - ø22	ø25 - ø50	ø50							CICT=3	CICT=4
P	Carbon steels S45C, S55C, etc. C45, C55, etc.	- 300HB	First choice Low resistance	AH3225	MJ ML	100 - 300	0.5 - 1.2	0.5 - 1.5	0.1	3,980	7,960	3,540	7,080	3,180	9,540	12,720	
	Alloy steels SCM440, SCr15, etc.	- 300HB	First choice Low resistance	AH3225	MJ ML	100 - 300	0.5 - 1.2	0.5 - 1.5	0.1	3,980	7,960	3,540	7,080	3,180	9,540	12,720	
	Prehardened steels NAK80, PX5, etc.	30 - 40HRC	First choice for impact resistance	AH8015 AH3225	MJ MJ	100 - 200	0.5 - 1	0.5 - 1	0.1	2,980	4,770	2,650	4,240	2,390	5,740	7,650	
M	Stainless steels SUS304, X5CrNi18-9, etc.	- 200HB	First choice for impact resistance	AH130	ML MJ	80 - 150	0.3 - 1	0.3 - 1	0.1	2,390	2,870	2,120	2,550	1,910	3,440	4,590	
	Precipitation hardening stainless steels SUS630, X5CrNiCuNb16-4, etc.	28HRC - 40HRC -	First choice for impact resistance	AH130	ML MJ ML	80 - 150	0.3 - 0.8	0.3 - 0.8	0.1	2,390	2,390	2,120	2,120	1,910	2,870	3,820	
			First choice for impact resistance	AH130	MJ	80 - 120	0.3 - 0.5	0.3 - 0.5	0.1	1,990	1,600	1,770	1,420	1,590	1,910	2,550	
K	Gray cast irons FC250, GG25, 250, etc.	150 - 250HB	First choice for impact resistance	AH8015 AH3225	MJ MJ	100 - 300	0.5 - 1.2	0.5 - 1.5	0.1	3,980	7,960	3,540	7,080	3,180	9,540	12,720	
	Ductile cast irons FCD400, etc.	150 - 250HB	First choice for impact resistance	AH8015 AH3225	MJ MJ	80 - 200	0.5 - 1.2	0.5 - 1.5	0.1	2,980	5,960	2,650	5,300	2,390	7,170	9,560	
			First choice for impact resistance	AH3225	MJ	80 - 200	0.5 - 1.2	0.5 - 1.5	0.1	2,980	5,960	2,650	5,300	2,390	7,170	9,560	
S	Titanium alloy Ti-6Al-4V, etc.	- 40HRC	First choice for wear resistance	AH130 AH8015	MJ MJ	30 - 60	0.3 - 0.8	0.3 - 0.8	0.08	800	960	710	860	640	1,160	1,540	
	Heat-resistant alloy Inconel, Hastelloy, etc.	- 40HRC	First choice for impact resistance	AH8015	ML MJ	20 - 50	0.2 - 0.5	0.2 - 0.5	0.05	600	360	530	320	480	440	580	
H	Hot mold steel SKD61, X40CrMoV5-1, etc.	40 - 50HRC	First choice for impact resistance	AH8015 AH3225	MJ MJ	80 - 150	0.1 - 0.5	0.1 - 0.5	0.05	2,390	1,440	2,120	1,280	1,910	1,720	2,300	
	Hot mold steel of D.T.C materials DAC**, DH**, DIEVER, etc.	40 - 50HRC	First choice for impact resistance	AH8015 AH3225	MJ MJ	50 - 100	0.1 - 0.5	0.1 - 0.5	0.05	1,590	960	1,410	850	1,270	1,150	1,530	
	Cold mold steels SKD11, X153CrMoV12, etc.	50 - 60HRC	First choice	AH8005	MJ	50 - 70	0.1 - 0.3	0.1 - 0.3	0.03	1,190	480	1,060	430	950	570	760	

- When chips stay in the cutting zone during slotting or pocketing, use air blast to remove chips from the work area

- Tool overhang length must be as short as possible to avoid chatter. When the tool overhang length is long, decrease the number of revolutions and feed

## APPLICATION RANGE

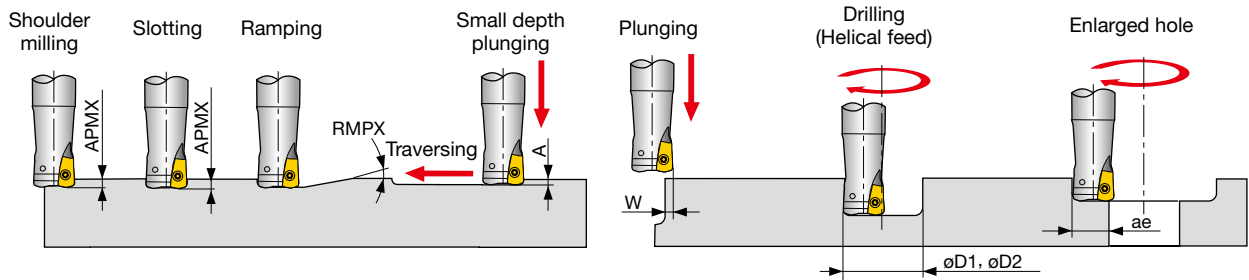

Designation	DCX	Max. depth of cut	Max. ramping angle	Max. plunging depth	Max. cutting width in plunging	Min. machinable hole dia.	Max. machinable hole dia.	Max. cutting width in enlarged hole
		APMX	RMPX	A	W	øD1	øD2	ae
E/HXN03R016M...	16	0.9	Not possible	Not possible	3.8	Not possible	Not possible	12.2
E/HXN03R018M...	18	0.9	1.7°	0.27	3.8	26	34	14.2
E/HXN03R020M...	20	0.9	1.4°	0.27	3.8	30	38	16.2
E/HXN03R022M...	22	0.9	1.2°	0.27	3.8	34	42	18.2
E/HXN03R025M...	25	0.9	1°	0.27	3.8	40	48	21.2
E/HXN03R028M...	28	0.9	0.8°	0.27	3.8	46	54	24.2
E/HXN03R030M...	30	0.9	0.7°	0.27	3.8	50	58	26.2
E/HXN03R032M...	32	0.9	0.7°	0.27	3.8	54	62	28.2
EXN03R035M...	35	0.9	0.6°	0.27	3.8	60	68	31.2
E/H/TXN03R040M...	40	0.9	0.5°	0.27	3.8	70	78	36.2
TXN03R050M...	50	0.9	0.4°	0.27	3.8	90	98	46.2

Note: For DCX above ø33 mm, slot milling, ramping or contouring is not recommended as chips may be re-cut

**Tool dia.: DCX (mm), Number of revolutions:  $n$  (min<sup>-1</sup>), Feed speed:  $V_f$  (mm/min), Max. depth of cut:  $a_p = 0.5$  mm, Number of teeth: CICT**

ø22			ø25			ø28			ø30			ø32			ø35			ø40			ø50		
$n$	$V_f$		$n$	$V_f$		$n$	$V_f$		$n$	$V_f$		$n$	$V_f$		$n$	$V_f$		$n$	$V_f$		$n$	$V_f$	
	CICT=3	CICT=4		CICT=4	CICT=5		CICT=4	CICT=5		CICT=4	CICT=5		CICT=5	CICT=6		CICT=5	CICT=6		CICT=5	CICT=6		CICT=5	CICT=6
2,890	8,670	11,560	2,550	10,200	12,750	2,270	9,080	11,350	2,120	8,480	10,600	1,990	9,950	11,940	1,820	9,100	10,920	1,590	7,950	9,540	1,270	6,350	10,160
Vc = 200 m/min, fz = 1 mm/t																							
2,890	8,670	11,560	2,550	10,200	12,750	2,270	9,080	11,350	2,120	8,480	10,600	1,990	9,950	11,940	1,820	9,100	10,920	1,590	7,950	9,540	1,270	6,350	10,160
Vc = 200 m/min, fz = 1 mm/t																							
2,170	5,210	6,950	1,910	6,120	7,640	1,710	5,480	6,840	1,590	5,090	6,360	1,490	5,960	7,160	1,360	5,440	6,530	1,190	4,760	5,720	950	3,800	6,080
Vc = 150 m/min, fz = 0.8 mm/t																							
1,740	3,140	4,180	1,530	3,680	4,590	1,360	3,270	4,080	1,270	3,050	3,810	1,190	3,570	4,290	1,090	3,270	3,930	950	2,850	3,420	760	2,280	3,650
Vc = 120 m/min, fz = 0.6 mm/t																							
1,740	2,610	3,480	1,530	3,060	3,830	1,360	2,720	3,400	1,270	2,540	3,180	1,190	2,980	3,570	1,090	2,730	3,270	950	2,380	2,850	760	1,900	3,040
Vc = 120 m/min, fz = 0.5 mm/t																							
1,450	1,740	2,320	1,270	2,040	2,540	1,140	1,830	2,280	1,060	1,700	2,120	990	1,980	2,380	910	1,820	2,190	800	1,600	1,920	640	1,280	2,050
Vc = 100 m/min, fz = 0.4 mm/t																							
2,890	8,670	11,560	2,550	10,200	12,750	2,270	9,080	11,350	2,120	8,480	10,600	1,990	9,950	11,940	1,820	9,100	10,920	1,590	7,950	9,540	1,270	6,350	10,160
Vc = 200 m/min, fz = 1 mm/t																							
2,170	6,510	8,680	1,910	7,640	9,550	1,710	6,840	8,550	1,590	6,360	7,950	1,490	7,450	8,940	1,360	6,800	8,160	1,190	5,950	7,140	950	4,750	7,600
Vc = 150 m/min, fz = 1 mm/t																							
580	1,050	1,400	510	1,230	1,530	450	1,080	1,350	420	1,010	1,260	400	1,200	1,440	360	1,080	1,300	320	960	1,160	250	750	1,200
Vc = 40 m/min, fz = 0.6 mm/t																							
430	390	520	380	460	570	340	410	510	320	390	480	300	450	540	270	410	490	240	360	440	190	290	460
Vc = 30 m/min, fz = 0.3 mm/t																							
1,740	1,570	2,090	1,530	1,840	2,300	1,360	1,640	2,040	1,270	1,530	1,910	1,190	1,790	2,150	1,090	1,640	1,970	950	1,430	1,710	760	1,140	1,830
Vc = 120 m/min, fz = 0.3 mm/t																							
1,160	1,050	1,400	1,020	1,230	1,530	910	1,100	1,370	850	1,020	1,280	800	1,200	1,440	730	1,100	1,320	640	960	1,160	510	770	1,230
Vc = 80 m/min, fz = 0.3 mm/t																							
870	530	700	760	610	760	680	550	680	640	520	640	600	600	720	550	550	660	480	480	580	380	380	610
Vc = 60 m/min, fz = 0.2 mm/t																							

- The above table shows the conditions for standard shank type cutters. When using long shank type cutters, the number of teeth may be different.
- Cutting conditions are generally limited by the rigidity and power of the machine and the

rigidity of the workpiece. When setting the conditions, start from half of the values of the standard cutting conditions and then increase the value gradually while making sure the machine is running normally

## TOOL GEOMETRY ON PROGRAMMING

When programming for CAM, the tool should be considered as a radius cutter. Usually, the corner radius should be set as  $R = 1.5$  mm. If a larger radius is used, overcutting will occur. The following table shows the amount left uncut ( $t_1$ ) and overcut ( $t_2$ ).

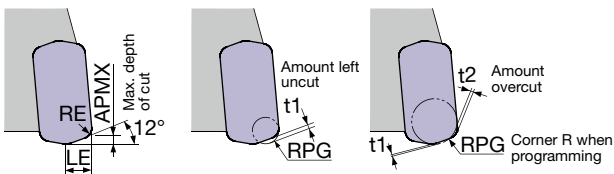

LNMU0303UER...

Max. depth of cut APMX (mm)	Corner radius RE (mm)	LE (mm)	Corner R when programming RPG	Amount left uncut $t_1$ (mm)	Amount overcut $t_2$ (mm)
0.9	1	3.5	1	0.48	-
<b>0.9</b>	<b>1</b>	<b>3.5</b>	<b>1.5</b>	<b>0.39</b>	-
0.9	1	3.5	2	0.3	0.12
0.9	1	3.5	2.5	0.21	0.31

Note: Each value in table is calculated theoretically at the maximum condition.

\*Recommended

Insert size 06

## For machining of medium- and large-sized components

Ultimate solution to typical machining challenges in exotic materials such as low productivity and short tool life

An ideal high feed cutter for machining exotic materials, DoFeed features small entry angle that, when combined with wiper inserts, provides **improved machining efficiency and tool life without compromising surface finishing quality.**



### W Wiper insert



**P M K S H**

#### 2 cutting edges

- To be mixed with other geometries
- The main cutting edge of the wiper has the same profile as with other chipbreaker geometry. This enables superior surface finish while maintaining the feed rate

### ■ The effect of wiper insert

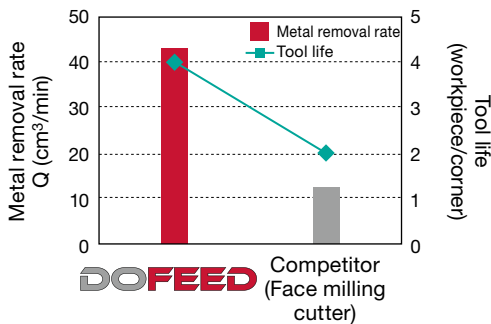

**S**

Cutter	: TXN06R063M22.0E06 (ø63 mm, CICT = 6) (Competitor: Face milling cutter)
Insert	: LNMU06X5ZER-ML : LNU06X5ZER-W (Competitor: Square, positive)
Grade	: AH130 (ML), AH725 (W), (Competitor: PVD, S30)
Workpiece material	: Titanium alloy (43HRC)
Cutting speed	: Vc = <b>38</b> m/min (Competitor: 25 m/min)
Feed per tooth	: fz = <b>0.64</b> mm/t (Competitor: 0.15 mm/t)
Feed speed	: Vf = <b>735</b> m/min (Competitor: 115 m/min)
Depth of cut	: ap = 1.25 mm (Competitor: 2.5 mm)
Width of cut	: ae = 45 mm
Coolant	: Wet (External coolant)

## CUTTING PERFORMANCE

**P** S55C / C55

### Comparison of surface finish

**Excellent surface finish!**

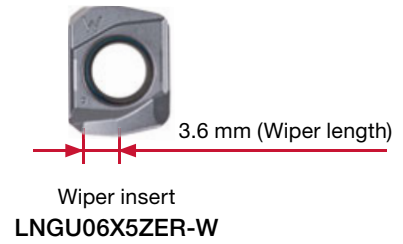
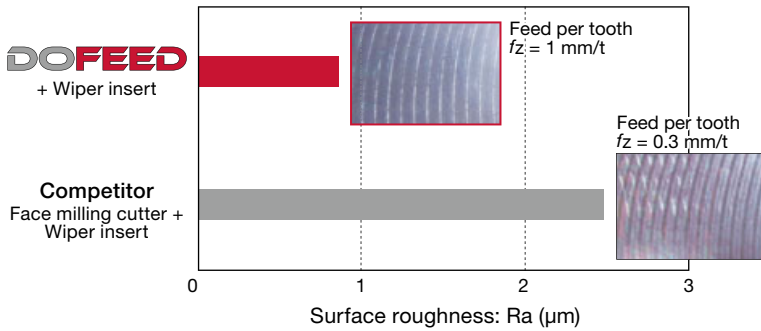

### Comparison of metal removal rate

**Tripled metal removal rate!**

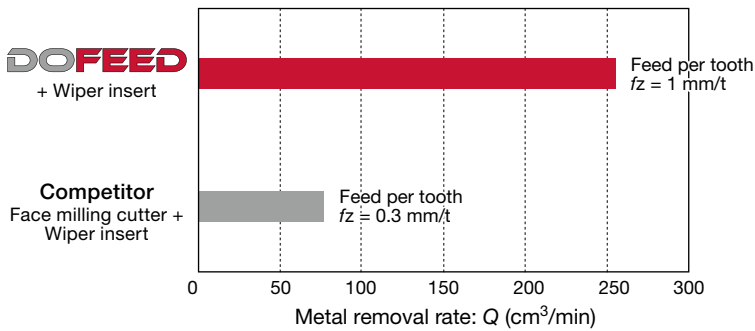

Cutter : TXN06R080M31.7-05  
 Insert : LNMU06X5ZER-ML AH725 x 3 inserts  
           : LNGU06X5ZER-W AH725 x 2 inserts  
 Cutting speed :  $V_c = 150$  m/min  
 Depth of cut :  $a_p = 1.5$  mm  
 Width of cut :  $a_e = 60$  mm  
 Coolant : Dry  
 Machine : Vertical M/C, BT50

Insert size 06

## TXN06

High feed mill, for 4-corner double sided inserts

GAMP = +10°, GAMF = +2° ~ +6°

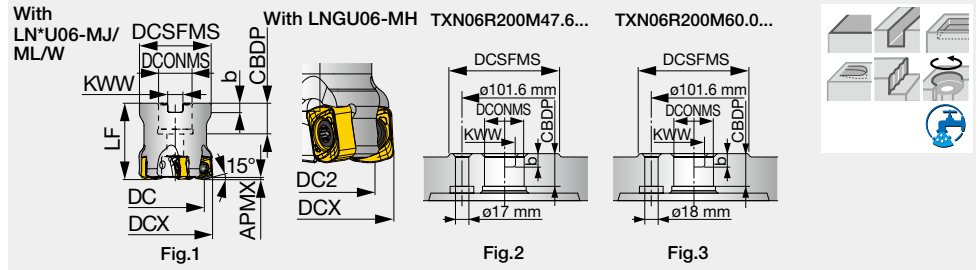

Designation	APMX	DCX	CICT	DC1	DC2	DCSFMS	LF	DCONMS	CBDP	KWW	b	WT (kg)	Air hole	Insert	Fig.
TXN06R050M22.0E04	1.5	50	4	37.6	36.9	47	50	22	20	10.4	6.3	0.4	with	LN*U06...	1
TXN06R050M22.0E05	1.5	50	5	37.6	36.9	47	50	22	20	10.4	6.3	0.4	with	LN*U06...	1
TXN06R050M22.2-04	1.5	50	4	37.6	36.9	47	50	22.225	20	8	5	0.4	with	LN*U06...	1
TXN06R050M22.2-05	1.5	50	5	37.6	36.9	47	50	22.225	20	8	5	0.4	with	LN*U06...	1
TXN06R052M22.0E04	1.5	52	4	39.6	38.9	49	50	22	20	10.4	6.3	0.5	with	LN*U06...	1
TXN06R052M22.0E05	1.5	52	5	39.6	38.9	49	50	22	20	10.4	6.3	0.5	with	LN*U06...	1
TXN06R063M22.0E04	1.5	63	4	50.6	49.8	59	50	22	20	10.4	6.3	0.8	with	LN*U06...	1
TXN06R063M22.0E06	1.5	63	6	50.6	49.8	59	50	22	20	10.4	6.3	0.8	with	LN*U06...	1
TXN06R063M22.2-04	1.5	63	4	50.6	49.8	59	50	22.225	20	8	5	0.8	with	LN*U06...	1
TXN06R063M22.2-06	1.5	63	6	50.6	49.8	59	50	22.225	20	8	5	0.8	with	LN*U06...	1
TXN06R066M27.0E04	1.5	66	4	53.6	52.8	63	50	27	22	12.4	7	0.8	with	LN*U06...	1
TXN06R066M27.0E06	1.5	66	6	53.6	52.8	63	50	27	22	12.4	7	0.8	with	LN*U06...	1
TXN06R080M27.0E05	1.5	80	5	67.6	66.8	76	63	27	22	12.4	7	1.6	with	LN*U06...	1
TXN06R080M27.0EE05	1.5	80	5	67.6	66.8	60	63	27	22	12.4	7	1.2	with	LN*U06...	1
TXN06R080M27.0E08	1.5	80	8	67.6	66.8	76	63	27	22	12.4	7	1.6	with	LN*U06...	1
TXN06R080M27.0EE08	1.5	80	8	67.6	66.8	60	63	27	22	12.4	7	1.2	with	LN*U06...	1
TXN06R080M31.7-05	1.5	80	5	67.6	66.8	76	63	31.75	32	12.7	8	1.6	with	LN*U06...	1
TXN06R080M31.7-08	1.5	80	8	67.6	66.8	76	63	31.75	32	12.7	8	1.6	with	LN*U06...	1
TXN06R100M31.7-06	1.5	100	6	87.6	86.8	96	63	31.75	32	12.7	8	2.2	with	LN*U06...	1
TXN06R100M32.0E06	1.5	100	6	87.6	86.8	96	63	32	25	14.4	8	2.2	with	LN*U06...	1
TXN06R125M38.1-08	1.5	125	8	112.6	111.8	100	63	38.1	43	15.9	10	3	with	LN*U06...	1
TXN06R125M40.0E08	1.5	125	8	112.6	111.8	100	63	40	37	16.4	9	3	with	LN*U06...	1
TXN06R160M40.0E10	1.5	160	10	147.6	146.8	100	63	40	37	16.4	9	5	with	LN*U06...	1
TXN06R160M50.8-10	1.5	160	10	147.6	146.8	100	63	50.8	46	19	11	4.6	with	LN*U06...	1
TXN06R200M47.6-12	1.5	200	12	187.6	186.8	130	63	47.625	38	25.4	14	7.7	without	LN*U06...	2
TXN06R200M60.0E12	1.5	200	12	187.6	186.8	130	63	60	38	25.7	14	7.2	without	LN*U06...	3

### SPARE PARTS

Designation	Clamping screw	Grip	Lubricant	Shell locking bolt 1	Shell locking bolt 2	Torx bit
TXN06R050M22.0...	CSPB-5	H-TB2W	M-1000	-	FSHM10-40H	BLD IP20/S7
TXN06R050M22.2-04	CSPB-5	H-TB2W	M-1000	-	CM10-30H	BLD IP20/S7
TXN06R050M22.2-05, TXN06R052M22.0...	CSPB-5	H-TB2W	M-1000	-	FSHM10-40H	BLD IP20/S7
TXN06R063M...	CSPB-5	H-TB2W	M-1000	-	CM10X30H	BLD IP20/S7
TXN06R066,080M27.0...	CSPB-5	H-TB2W	M-1000	-	CM12X30H	BLD IP20/S7
TXN06R080,100M31.7...	CSPB-5	H-TB2W	M-1000	-	CM16X40H	BLD IP20/S7
TXN06R125M...	CSPB-5	H-TB2W	M-1000	TMBA-M20H	-	BLD IP20/S7
TXN06R160M40.0...	CSPB-5	H-TB2W	M-1000	TMBA-M20H	-	BLD IP20/M7
TXN06R160M50.8...	CSPB-5	H-TB2W	M-1000	TMBA-M24H	-	BLD IP20/M7
TXN06R200M...	CSPB-5	H-TB2W	M-1000	-	-	BLD IP20/M7

\*Recommended clamping torque (N·m): CSPB-5=5

#### Tool diameter tolerance

Tool diameter 0 / -0.55

## EXN06

High feed endmill, shank type, for 4-corner double sided inserts

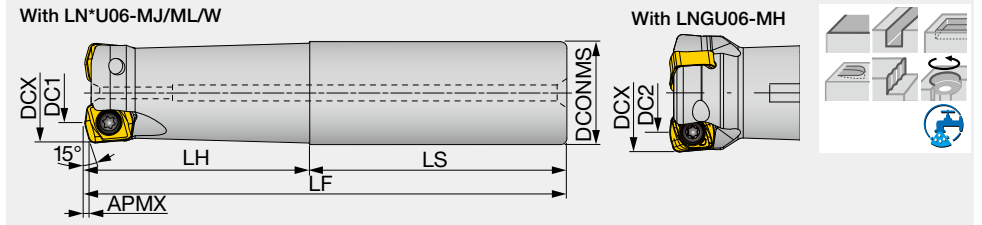

Designation	APMX	DCX	CICT	DC1	DC2	DCONMS	LF	LH	LS	WT (kg)	Air hole	Insert
EXN06R032M32.0-02	1.5	32	2	19.7	19.1	32	150	70	80	0.8	with	LN*U06...
EXN06R032M32.0-02L	1.5	32	2	19.7	19.1	32	200	120	80	1.1	with	LN*U06...
EXN06R035M32.0-02	1.5	35	2	22.7	22	32	150	45	105	0.9	with	LN*U06...
EXN06R035M32.0-02L	1.5	35	2	22.7	22	32	200	45	155	1.2	with	LN*U06...
EXN06R040M32.0-03	1.5	40	3	27.7	27	32	150	45	105	0.9	with	LN*U06...
EXN06R040M32.0-03L	1.5	40	3	27.7	27	32	220	45	175	1.3	with	LN*U06...

### SPARE PARTS

Designation	Clamping screw	Lubricant	Wrench	Tool diameter tolerance	
EXN06	CSPB-5	M-1000	IP-20D	Tool diameter	0 / -0.55

\*Recommended clamping torque (N·m): CSPB-5=5

## INSERT

### LNMU06-MJ (for general purpose)

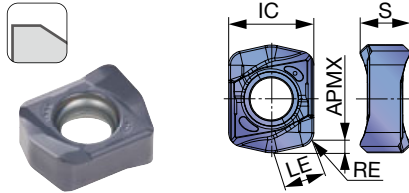

### LNMU06-ML (for low cutting force)

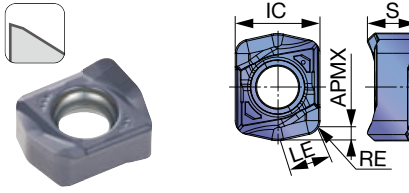

### LNGU06-MH (Robust cutting edges)

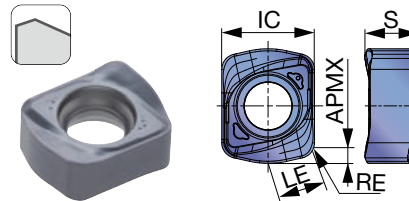

### LNMU06-W (Wiper, 2 cutting edge)

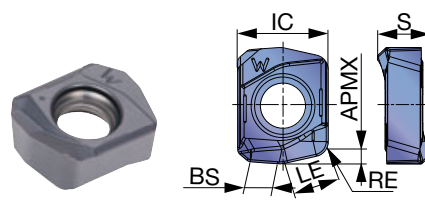

<b>P</b> Steel		★										
<b>M</b> Stainless	★	☆										
<b>K</b> Cast iron		☆	☆	★								
<b>N</b> Non-ferrous												
<b>S</b> Superalloys	★	☆	☆		★							
<b>H</b> Hard materials			☆		★	☆						

★ : First choice  
☆ : Second choice

Designation	RE	APMX	Coated						LE	IC	S	BS
			AH130	AH3225	AH725	AH120	AH8015	AH8005				
LNMU06X5ZER-MJ	2	1.5	●	●	●	●	●	●	6	12	7	-
LNMU06X5ZER-ML	2	1.5	●	●	●	●	●	●	6	12	7	-
LNGU06X5ZER-MH	2	1.5					●	●	6	12	7	-
LNGU06X5ZER-W	2	1.5			●				6	12	7	3.6

- When wiper insert (-W) is used, the value of feed per rev. (mm/rev) must be less than 3.6 mm x n. for keeping this value, the number of wiper insert (n) and feed per tooth (mm/tooth) should be adjusted  
- Wiper insert (-W) can be used just for face milling. It's not suitable for ramping or pocket milling

● : New product  
● : Line up

## STANDARD CUTTING CONDITIONS

ISO	Workpiece materials	Hardness	Priority	Grade	Chip-breaker	Cutting speed Vc (m/min)	Feed per tooth: fz (mm/t)		Feed per tooth: fz (mm/t)					
							Tool dia.: DCX (mm)	Plunging	ø32, CICT = 2		ø35, CICT = 2		ø40, CICT = 3	
									n	Vf	n	Vf	n	Vf
P	Carbon steels S45C, S55C, etc. C45, C55, etc.	- 300HB	First choice	AH3225	MJ	100 - 300	0.5 - 1.5	0.15	1,990	3,980	1,820	3,640	1,590	4,770
	Alloy steels SCM440, SCr415, etc.	- 300HB	First choice	AH3225	MJ	100 - 200	0.5 - 1.5	0.15	1,990	3,980	1,820	3,640	1,590	4,770
	Prehardened steels NAK80, PX5, etc.	30 - 40HRC	First choice	AH3225	MJ	100 - 200	0.5 - 1.2	0.15	1,490	2,380	1,360	2,180	1,190	2,860
		30 - 40HRC	for wear resistance	AH8015	MJ	100 - 200	0.5 - 1.5	0.15	1,490	2,980	1,360	2,720	1,190	3,570
M	Stainless steels SUS304, X5CrNi18-9, etc.	- 200HB	First choice	AH130	ML	80 - 150	0.3 - 0.8	0.1	1,190	1,430	1,090	1,310	950	1,710
	Precipitation hardening stainless steels SUS630, X5CrNiCuNb16-4, etc.	28HRC-(H1150)	First choice	AH130	ML	80 - 150	0.2 - 0.5	0.1	1,190	710	1,090	650	960	860
		40HRC - (H900)	for impact resistance	AH130	MJ	80 - 120	0.1 - 0.3	0.1	1,000	400	910	360	800	480
		for impact resistance	AH130	MJ	Vc = 100 m/min, fz = 0.2 mm/t									
K	Gray cast irons FC250, GG25, 250, etc.	150 - 250HB	First choice	AH120	MJ	100 - 300	0.5 - 1.5	0.15	1,990	3,980	1,820	3,640	1,590	4,770
		150 - 250HB	First choice	AH120	MJ	80 - 200	0.5 - 1.5	0.15	1,490	2,980	1,360	2,720	1,190	3,570
S	Titanium alloy Ti-6Al-4V, etc.	- 40HRC	First choice	AH130	ML	30 - 60	0.3 - 0.7	0.08	400	400	360	360	320	480
	Heat-resistant alloy Inconel, Hastelloy, etc.	- 40HRC	for impact resistance	AH8015	ML	20 - 50	0.1 - 0.3	0.05	300	120	270	110	240	140
H	Hot mold steel SKD61, X40CrMoV5-1, etc.	40 - 55HRC	First choice	AH8015	MH	80 - 150	0.1 - 0.5	0.05	1,190	710	1,090	650	950	850
			Low resistance	AH8015	MJ		0.1 - 0.3		Vc = 120 m/min, fz = 0.3mm/t					
	Hot mold steel of D.T.C materials DAC**, DH**, DIEVER, etc	40 - 55HRC	First choice	AH8015	MJ	50-100	0.1 - 0.3	0.05	800	320	730	290	640	380
			for impact resistance	AH8015	MH		0.1 - 0.5		Vc = 80 m/min, fz = 0.2mm/t					
Cold mold steels SKD11, X153CrMoV12, etc.	55 - 60HRC	First choice	AH8005	MH	50 - 70	0.05 - 0.3	0.03	600	120	550	110	480	140	
	55 - 60HRC	for impact resistance	AH8015	MH	50 - 70	0.05 - 0.3	0.03	600	60	550	55	480	70	

- The above table shows the conditions for standard shank type cutters. When using long shank type cutters, the number of teeth may be different.  
 - Cutting conditions are generally limited by the rigidity and power of the machine

and the rigidity of the workpiece. When setting the conditions, start from half of the values of the standard cutting conditions and then increase the value gradually while making sure the machine is running normally

## APPLICATION RANGE

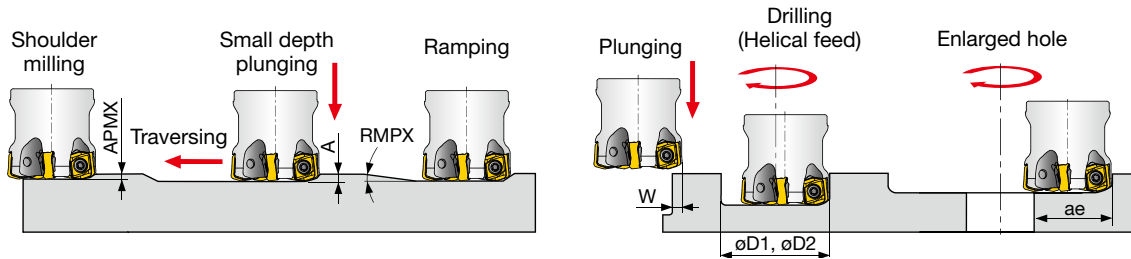

Designation	DCX	Max. depth of cut APMX	Max. ramping angle RMPX		Max. plunging depth A	Max. cutting width in plunging W	Min. machinable hole dia. øD1	Max. machinable hole dia. øD2	Max. cutting width in enlarged hole ae	
			MJ/ML	MH						
			MJ/ML	MH						
EXN06R032M...	32	1.5	2	1.4	0.5	0.4	6	47	59	25
EXN06R035M...	35	1.5	1.7	1.1	0.5	0.4	6	53	65	28
EXN06R040M...	40	1.5	1.3	0.8	0.5	0.4	6	63	75	33
TXN06R050M...	50	1.5	0.9	0.7	0.5	0.4	6	83	95	43
TXN06R052M...	52	1.5	0.8	0.6	0.5	0.4	6	87	99	45
TXN06R063M...	63	1.5	0.6	0.5	0.5	0.4	6	109	121	56
TXN06R066M...	66	1.5	0.5	0.5	0.5	0.4	6	115	127	59
TXN06R080M...	80	1.5	0.5	0.3	0.5	0.4	6	143	155	73
TXN06R100M...	100	1.5	0.34	0.25	0.5	0.4	6	183	195	93
TXN06R125M...	120	1.5	0.26	0.2	0.5	0.4	6	233	245	118
TXN06R160M...	160	1.5	0.2	0.15	0.5	0.4	6	303	315	153
TXN06R200M...	200	1.5	0.15	0.11	0.5	0.4	6	383	395	193

Note: For DCX above 100 mm, slot milling, ramping or contouring is not recommended as chips may be re-cut.



## BT50-FM

Shell mill holder, long type (BT)

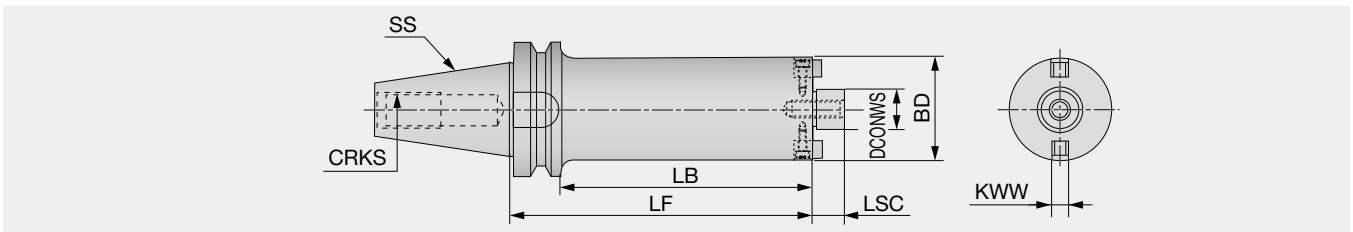

Designation	SS	DCONWS	BD	LSC	LF	LB	CRKS	KWW	WT(kg)
BT50-FMC22-138-47	50	22	47	18	138	100	M24	10	5.2
BT50-FMC22-188-47	50	22	47	18	188	150	M24	10	5.9
BT50-FMC22-243-47	50	22	47	18	243	205	M24	10	6.5
BT50-FMC22-293-47	50	22	47	18	293	255	M24	10	7.2
BT50-FMC22-178-59	50	22	59	18	178	140	M24	10	6.8
BT50-FMC22-238-59	50	22	59	18	238	200	M24	10	8
BT50-FMC22-308-59	50	22	59	18	308	270	M24	10	9.5
BT50-FMC22-373-59	50	22	59	18	373	335	M24	10	10.9
BT50-FMA31.75-215-76	50	31.75	76	30	215	177	M24	12.7	10
BT50-FMA31.75-295-76	50	31.75	76	30	295	257	M24	12.7	12.9
BT50-FMA31.75-375-76	50	31.75	76	30	375	337	M24	12.7	15.8
BT50-FMA31.75-275-96	50	31.75	96	30	275	237	M24	12.7	16.8
BT50-FMA31.75-375-96	50	31.75	96	30	375	337	M24	12.7	23

Option: Wrench for collet

## DIN69871-SEM

Shell mill holder with coolant hole, long type (DIN69871)

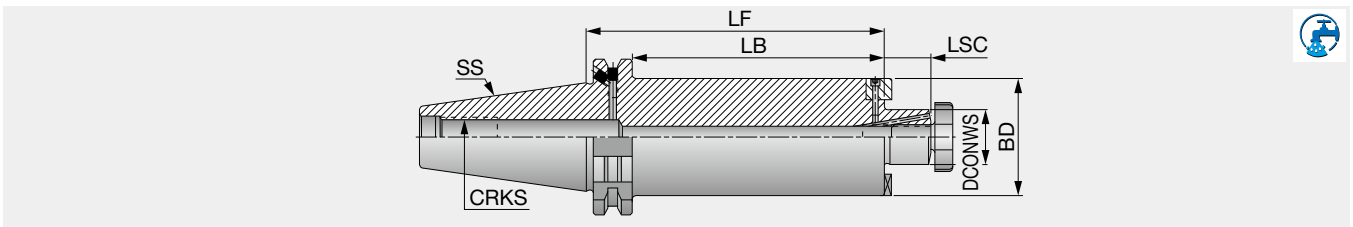

Designation	SS	DCONWS	LSC	BD	LF	LB	CRKS
DIN6987150SEM22X48X200C	50	22	19	48	200	181	M24
DIN6987150SEM22X61X300C	50	22	19	61	300	281	M24
DIN6987150SEM27X61X300C	50	27	21	61	300	281	M24
DIN6987150SEM32X78X370C	50	32	24	78	370	351	M24

- Applicable for 10 MPa coolant

- When being used as a flange-through type, the plug screw must be removed from the flange with a 2-mm hex key

Option: Wrench for center bolt

## BT-SEM-C

Shell mill holder with coolant hole, long type (BT)

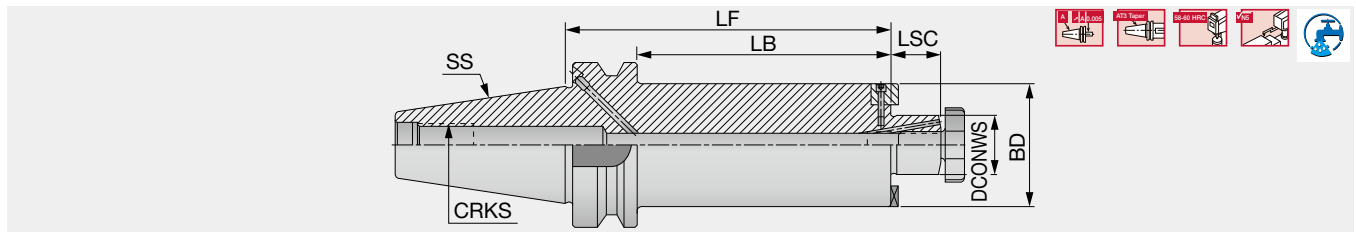

Designation	SS	DCONWS	BD	LF	LB	LSC	CRKS
BT40SEM16X60C	40	16	38	60	33	17	M16
BT40SEM16X100C	40	16	38	100	73	17	M16
BT40SEM22X100C	40	22	47	100	73	19	M16
BT40SEM27X100C	40	27	58	100	73	21	M16
BT40SEM32X60C	40	32	66	60	33	24	M16
BT50SEM16X100C	50	16	38	100	62	17	M24
BT50SEM22X75C	50	22	47	75	37	19	M24
BT50SEM22X48X220C	50	22	48	220	182	19	M24
BT50SEM22X61X320C	50	22	61	320	282	19	M24
BT50SEM25.4X60C	50	25.4	50.4	60	22	22	M24
BT50SEM27X100C	50	27	58	100	62	21	M24
BT50SEM27X61X320C	50	27	61	320	282	21	M24
BT50SEM32X75C	50	32	66	75	37	24	M24
BT50SEM32X100C	50	32	66	100	62	24	M24
BT50SEM32X78X390C	50	32	78	390	352	24	M24

- Applicable for 10 MPa coolant

- When being used as a flange-through type, the plug screw must be removed from the flange with a 2-mm hex key

Option: Wrench for lock screw

## SM TungFlex-straight shank

Screw-clamp holder for modular heads (straight shank)

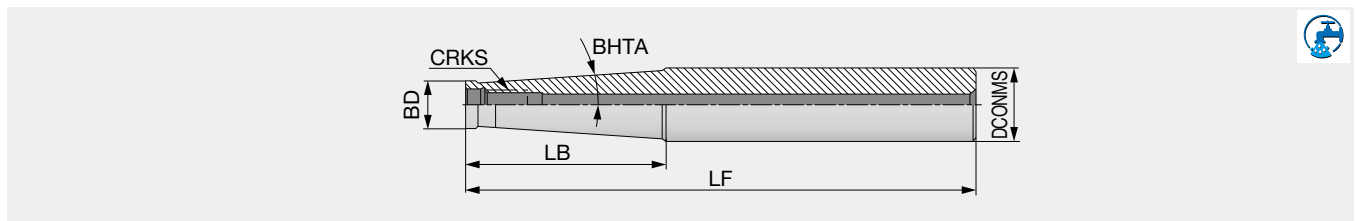

Designation	DCONMS	BD	LF	LB	BHTA	CRKS
SM06-L60C10	10	9.7	60	20	0°	M6
SM06-L105-C12	12	9.7	105	60	1.2°	M6
SM06-L125-C16	16	9.7	125	60	3.3°	M6
SM08-L73C16	16	13	73	25	0°	M8
SM08-L128-C16	16	13	128	80	0.9°	M8
SM08-L170-C20	20	13	170	66.8	3.3°	M8
SM10-L80C20	20	18	80	30	0°	M10
SM10-L130-C20	20	18	130	80	0.6°	M10
SM10-L200-C25	25	19	200	57.2	3.3°	M10
SM12-L86-C25	25	21	86	30	5.1°	M12
SM12-L200-C32	32	21	200	78	4.4°	M12
SM16-L95-C32	32	29	95	35	1.7°	M16
SM16-L230-C32	32	29	230	50	1.8°	M16

- Applicable for 10 MPa coolant

- A coolant hole with all types of shanks

## TECHNICAL GUIDE FOR OPTIMUM TOOLING

### ● For long overhang tool setup

#### The number of teeth

When using a tool overhang of over 4xD up to 6xD, extra care must be taken in determining the number of teeth and the cutting parameters to be used for the application.

A cutter body with **standard tooth pitch** must be selected as a minimum number of teeth are always in contact with the workpiece simultaneously for maximum tool stability.

#### Cutting parameter settings

The cutting parameters must be set **within the range as described below**.

For a tool overhang of over 6xD, use a taper shank or carbide shank holder or **BoreMeister** holder with vibration dampening for extra machining stability.

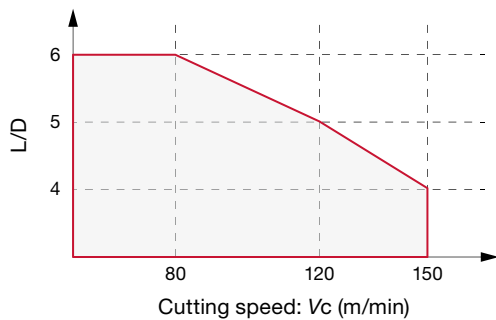

#### Chipbreakers

Soft cutting inserts eliminate chatter and provide stability during machining.

Four different chipbreaker styles of **DoFeed** inserts are described below in order from the lowest cutting load to the highest.

Select a softer cutting chipbreaker when excess chatter occurs.

(All four chipbreakers are not available for all insert sizes. See the list below for chipbreaker availability for each insert size.)

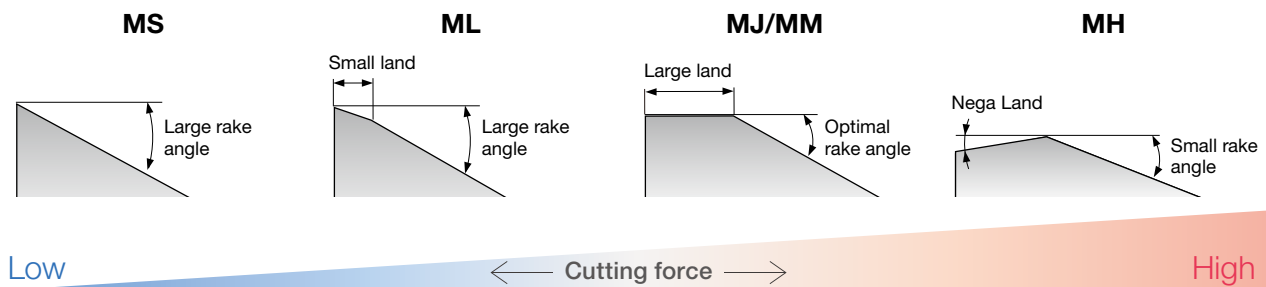

Chipbreaker availability for each insert size

Insert size	MS	ML	MJ/MM	MH
02	-	-	✓	-
03	✓	✓	✓	✓
06	-	✓	✓	✓

## ● Milling of shoulders located deep

Extra care must be taken for work-tool interference.

For **straight bodies**, whose cutter and shank diameters are identical, maximum axial cutting depth that allows machining without interference will be: **Head Length (LH) - 2 mm**.

To avoid tool interference with the workpiece, use reduced-shank cutter bodies or modular system tools, whose cutter diameter is larger than the shank diameter.

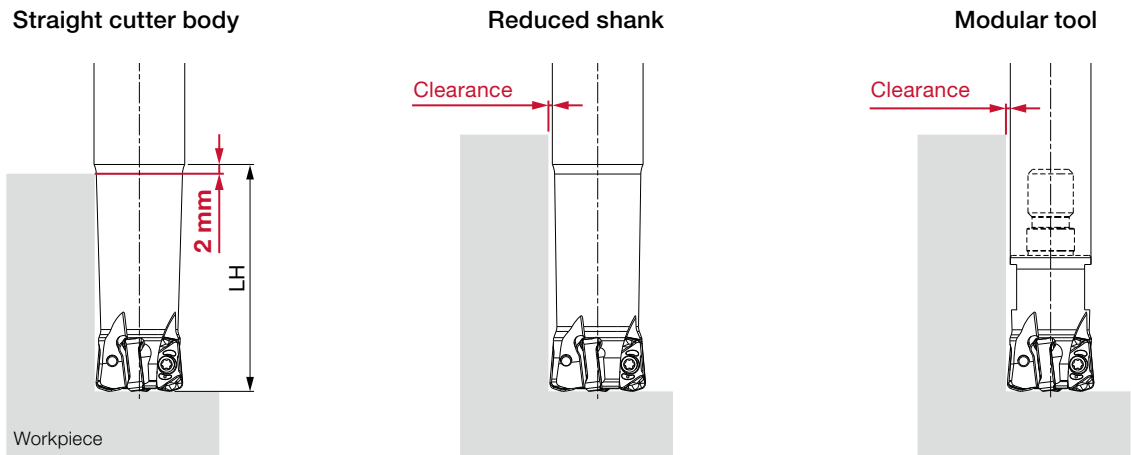

## ● Insert selection for machining hard materials

The following list shows optimal insert grade and chipbreaker selections for different hardness scale ranges.

H	Hardness range of the workpiece (HRC)	Chipbreaker		Grade		
		First choice	MJ/MM	First choice	Grade	
	- 40	First choice	MJ/MM	●	First choice	AH3225
		For soft cutting/ built-up edge resistance	ML		●	Wear resistance
	40 - 45	First choice	MJ/MM	●	First choice	AH3225
		For impact resistance	MH		●	Wear resistance
	45 - 55	First choice	MH	●	First choice	AH8015
					Wear resistance	AH8005
	55 - 60	First choice	MH	●	First choice	AH8005
					Impact resistance	AH8015

## ● Common fracture patterns and remedies

Flank wear is one of the common, and ideal, wear mode. However, most inserts end up with fracture wear due to the interrupted nature of the milling process.

Fracture wear can be caused by various factors, and the most common causes are outlined below.

### Fracture caused by a weak cutting edge

#### How to identify

Small edge chipping or noticeable series of chippings along the cutting edge

#### Common applications

Heavy interrupted cuts; milling of rough surfaces such as cast or hot forged workpieces, welded parts, or hardened steel



#### Remedies

<b>Insert</b>	Use an insert grade with higher fracture resistance (see page 6) Use chipbreaker with a stronger cutting edge (see page 34)
<b>Cutting conditions</b>	↓ Decrease cutting speed

### Fracture caused when built-up edge is torn away

#### How to identify

An accumulation of material against the rake face

#### Common applications

Low speed cutting, dry milling, milling of gummy material



#### Remedies

<b>Insert</b>	Use an insert grade with higher fracture resistance (see page 6) Use a chipbreaker with sharp cutting edges (see page 34)
<b>Cutting conditions</b>	↑ Increase cutting speed. Use coolant.

## Fracture caused by **thermal cracks**

### How to identify

Cracks in the tool perpendicular to the cutting edge

### Common applications

High speed cutting, milling using coolant, large diameter cutter, machining of high temp alloys

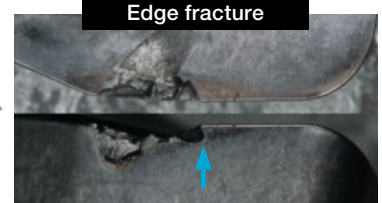
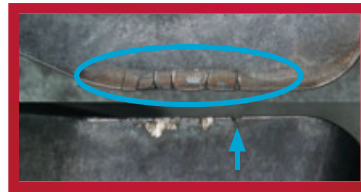

### Remedies

<b>Insert</b>	Use an insert grade with higher fracture resistance (see page 6) Use a chipbreaker with sharp cutting edges (see page 34) For Size 03, use UER inserts for thinner chips
<b>Cutting conditions</b>	↓ Decrease cutting speed. Use dry machining.

## Fracture caused by **crater wear**

### How to identify

Wear appears on the rake face at a short distance from cutting edge  
Typical at the depth of cut line and on the bottom cutting edges

### Common applications



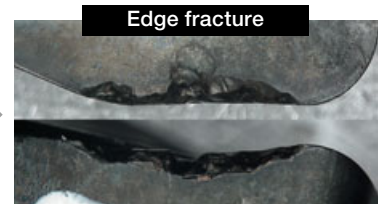

High speed cutting, high feed cutting at  $fz \geq 1$  mm/z, machining of high-tensile steel





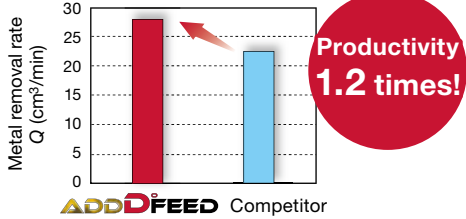
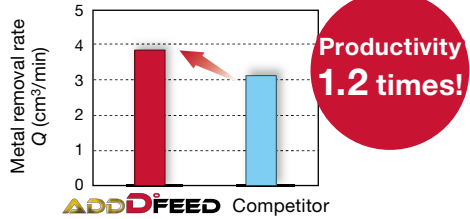

### Remedies

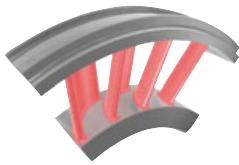
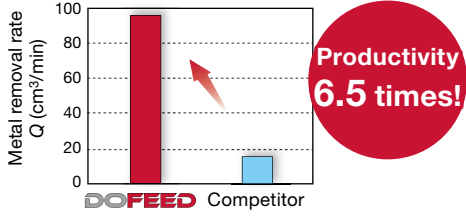
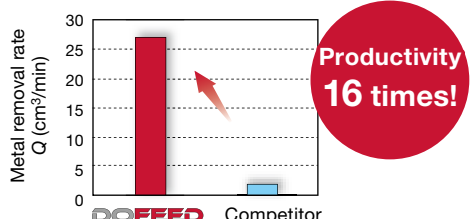
<b>Insert</b>	Use an insert grade with higher wear resistance (see page 6) Use a chipbreaker with sharp cutting edges (see page 34) For Size 03, use UER inserts for thinner chips
<b>Cutting conditions</b>	↓ Decrease cutting speed. ↓ Decrease feed per tooth

## PRACTICAL EXAMPLES

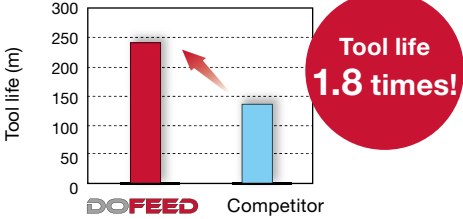
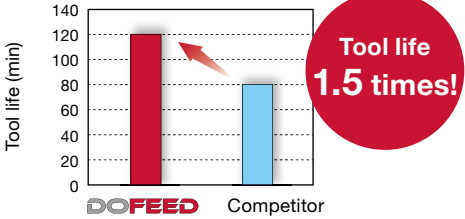
Workpiece type		Compressor shaft	Gas turbine component	
Cutter		EXN02R010M10.0-02 (ø10 mm, CICT = 2)	EXN02R012M12.0-02 (ø12 mm, CICT = 2)	
Insert		LNMU0202ZER-MM	LNMU0202ZER-MM	
Grade		AH3225	AH130	
Workpiece material		SNCM439 (42HRC)	SUH660	
		 <b>P</b>	 <b>M</b>	
Cutting conditions	Cutting speed : Vc (m/min)	180	60	
	Feed per tooth: fz (mm/t)	0.6	0.5	
	Depth of cut : ap (mm)	0.4	0.3	
	Width of cut : ae (mm)	10	8	
	Machining	Slotting	Shoulder milling	
	Coolant	Wet	Wet	
	Machine	Vertical M/C, BT30	Vertical M/C, BT50	
Results	 <p><b>Productivity 1.2 times!</b></p> <p>ADD<sup>o</sup>FEED Competitor</p> <p>AddDoFeed eliminated chatter despite high cutting speed thanks to low cutting force, gaining productivity by 1.2 times.</p>		 <p><b>Productivity 1.2 times!</b></p> <p>ADD<sup>o</sup>FEED Competitor</p> <p>AddDoFeed's small depth of cut, but much faster feed improved productivity by 1.2 times.</p>	
	<p>AddDoFeed eliminated chatter despite high cutting speed thanks to low cutting force, gaining productivity by 1.2 times.</p>		<p>AddDoFeed's small depth of cut, but much faster feed improved productivity by 1.2 times.</p>	
Workpiece type		Mould base	Turbine blade	
Cutter		EXN03R025M25.0-05 (ø25 mm, CICT = 5)	EXN03R030M32.0-05 (ø30 mm, CICT = 5)	
Insert		LNMU0303ZER-MJ	LNMU0303ZER-ML	
Grade		AH725	AH725	
Workpiece material		SC360	Heat resistant cast steel	
		 <b>P</b>	 <b>S</b>	
Cutting conditions	Cutting speed : Vc (m/min)	140	70	
	Feed per tooth: fz (mm/t)	0.48	0.5	
	Depth of cut : ap (mm)	0.9	0.5	
	Width of cut : ae (mm)	25	30	
	Machining	Slot milling	Shoulder milling	
	Coolant	Dry	Wet	
	Machine	Horizontal M/C, BT50	Vertical M/C, BT50	
Results	 <p><b>Productivity 6.5 times!</b></p> <p>DOFEED Competitor</p> <p>Thanks to DoFeed's light cutting geometry, the MRR has improved by 650%, while maintaining the same level of, or even reduced, spindle load as the competitor's tool. Chip re-cutting has significantly reduced, while increasing the tool life by 7-fold.</p>		 <p><b>Productivity 16 times!</b></p> <p>DOFEED Competitor</p> <p>Tripled cutting speed and super high feed milling offer 16 times higher productivity.</p>	
	<p>Thanks to DoFeed's light cutting geometry, the MRR has improved by 650%, while maintaining the same level of, or even reduced, spindle load as the competitor's tool. Chip re-cutting has significantly reduced, while increasing the tool life by 7-fold.</p>		<p>Tripled cutting speed and super high feed milling offer 16 times higher productivity.</p>	

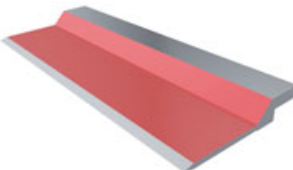
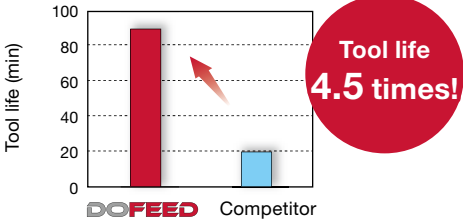
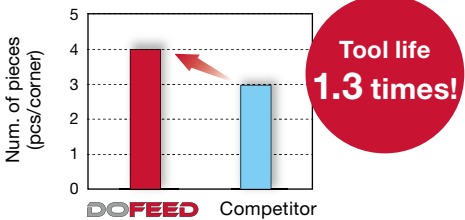
Workpiece type		Die & Mould	Aircraft part
Cutter		HXN03R025MM12-05 (ø25 mm, CICT = 5)	EXN03R025M25.0-05-C (ø25 mm, CICT = 5)
Insert		LNMU0303UER-MJ	LNMU0303UER-ML
Grade		AH3225	AH130
Workpiece material		SKD61 / X40CrMoV5-1 (45HRC)	15-5PH
		 <b>P</b>	 <b>M</b>
Cutting conditions	Cutting speed : Vc (m/min)	118	105
	Feed per tooth: fz (mm/t)	0.4	0.33
	Depth of cut : ap (mm)	0.5	0.76
	Width of cut : ae (mm)	- 25	- 25
	Machining	Contouring	Profiling
	Coolant	Dry	Wet
Machine		Vertical M/C, HSK63	Vertical M/C, BT40
Results		 <p><b>Tool life 1.8 times!</b></p> <p>UER inserts in AH3225 grade provided 180% tool life increase.</p>	 <p><b>Tool life 1.5 times!</b></p> <p>UER inserts provided 150% tool life increase in exotic material.</p>
Workpiece type		Die & Mould	Press-cutter blade
Cutter		TXN06R063M22.0E04 (ø63 mm, CICT = 4)	TXN06R063M22.0E06 (ø63 mm, CICT = 6)
Insert		LNMU06X5ZER-MJ	LNGU06X5ZER-MH
Grade		AH3225	AH8015
Workpiece material		S45C / C45 (20 - 35 HRC)	SCM440/42CrMo4(44HRC)
		 <b>P</b>	 <b>H</b>
Cutting conditions	Cutting speed : Vc (m/min)	197	118
	Feed per tooth: fz (mm/t)	1.5	0.8
	Depth of cut : ap (mm)	0.75	0.8
	Width of cut : ae (mm)	45	38
	Machining	Contouring	Face milling
	Coolant	Dry	Dry
Machine		Vertical M/C, BT50	Vertical M/C
Results		 <p><b>Tool life 4.5 times!</b></p> <p>AH3225 reduced the damage of the bottom cutting edge, extending tool life by 4.5 times.</p>	 <p><b>Tool life 1.3 times!</b></p> <p>A combination of the MH chipbreaker and AH8015 reduced chipping and wear. Tool life has increased to 130%.</p>

### **Tungaloy Corporation (Head office)**

11-1 Yoshima-Kogyodanchi  
Iwaki-city, Fukushima 970-1144 Japan  
Phone: +81-246-36-8501  
Fax: +81-246-36-8542  
www.tungaloy.co.jp

### **Tungaloy-NTK America Inc.**

3726 N Ventura Drive  
Arlington Heights, IL 60004, U.S.A.  
Phone: +1-888-554-8394  
Fax: +1-888-554-8392  
www.tungaloy.com/us

### **Tungaloy Canada**

432 Elgin St. Unit 3  
Brantford, Ontario N3S 7P7, Canada  
Phone: +1-519-758-5779  
Fax: +1-519-758-5791  
www.tungaloy.com/ca

### **Tungaloy-NTK De Mexico S.A.**

C. Los Arellano 113,  
Parque Industrial Siglo XXI  
Aguascalientes, AGS, Mexico 20290  
Phone: +52-449-929-5410  
Fax: +52-449-929-5411  
www.tungaloy.com/mx

### **Tungaloy-NTK do Brasil Ltda.**

Avd. Independencia N4158 Residencial Flora  
13280-000 Vinhedo, São Paulo, Brasil  
Phone: +55-19-38262757  
Fax: +55-19-38262757  
www.tungaloy.com/br

### **Tungaloy-NTK Germany GmbH.**

Katzbergstr. 3a  
D-40764 Langenfeld, Germany  
Phone: +49-2173-90420-0  
Fax: +49-2173-90420-19  
www.tungaloy.com/de

### **Tungaloy France s.a.s**

Les Fjords  
19 avenue de Norvège  
91140 Villebon Sur Yvette, France  
Phone: +33-1-6486-4300  
Fax: +33-1-6907-7817  
www.tungaloy.com/fr

### **Tungaloy Italia S.r.l.**

Via E. Andolfato 10  
I-20126 Milano, Italy  
Phone: +39-02-252012-1  
Fax: +39-02-252012-65  
www.tungaloy.com/it

### **Tungaloy Czech s.r.o.**

Turanka 115  
CZ-627 00 Brno, Czech Republic  
Phone: +420-532 123 391  
Fax: +420-532 123 392  
www.tungaloy.com/cz

### **Tungaloy Ibérica S.L.**

C/Miquel Servet, 43B, Nau 7  
Pol. Ind. Bufalvent  
ES-08243 Manresa (BCN), Spain  
Phone: +34 93 113 1360  
www.tungaloy.com/es

### **Tungaloy Scandinavia AB**

Bultgatan 38  
442 40 Kungälv, Sweden  
Phone: +46-462119200  
Fax: +46-462119207  
www.tungaloy.com/se

### **Tungaloy Rus, LLC**

Andropova avenue, h.18/7,  
11 floor, office 3, 115432,  
Moscow, Russia  
Phone: +7-499-683-01-80  
Fax: +7-499-683-01-81  
www.tungaloy.com/ru

### **Tungaloy Polska Sp. z o.o.**

Ul. Irysowa 1, 55-040 Bielany  
Wroclawskie, Poland  
Phone: +48 607 907 237  
www.tungaloy.com/pl

### **Tungaloy-NTK UK Ltd.**

Suite 3, Pioneer House, Mill Street,  
Cannock, WS11 0EF, UK  
Phone: +44 121 4000 231  
Fax: +44 121 270 9694  
www.tungaloy.com/uk

### **Tungaloy Hungary Kft**

Erzsébet királyné útja 125  
H-1142 Budapest, Hungary  
Phone: +36 1 781-6846  
Fax: +36 1 781-6866  
www.tungaloy.com/hu

### **Tungaloy Turkey**

Serifali Mah.bayraktar Bulvari Kule Sk. No:26  
34775 Umraniye / Istanbul / Turkey  
Phone: +90 216 540 04 67  
Fax: +90 216 540 04 87  
www.tungaloy.com/tr

### **Tungaloy Benelux b.v.**

Tjalk 70  
NL-2411 NZ Bodegraven, Netherlands  
Phone: +31 172 630 420  
Fax: +31 172 630 429  
www.tungaloy.com/nl

### **Tungaloy Croatia**

Ulica bana Josipa Jelačića 87,  
10430, Samobor, Croatia  
Phone: +385 1 3326 604  
Fax: +385 1 3327 683  
www.tungaloy.com/hr

### **Tungaloy Cutting Tool (Shanghai) Co. Ltd.**

Rm No 401 No.88 Zhabei  
Jiangchang No.3 Rd  
Shanghai 200436, China  
Phone: +86-21-3632-1880  
Fax: +86-21-3621-1918  
www.tungaloy.com/cn

### **Tungaloy Cutting Tools Taiwan Co. Ltd.**

9F, No.293, Zhongyang Rd,  
Xinzhuang Dist, New Taipei City,  
24251 Taiwan  
Phone: +886-2-8521-9986  
Fax: +886-2-8521-8935  
www.tungaloy.com/tw

### **Tungaloy-NTK Cutting Tool (Thailand) Co.,Ltd.**

Interlink tower 4th Fl.  
1858/5-7 Bangna-Trad Road  
km.5 Bangna, Bangna, Bangkok 10260  
Thailand  
Phone: +66-2-751-5711  
Fax: +66-2-751-5715  
www.tungaloy.com/th

### **Tungaloy Singapore (Pte.), Ltd.**

62 Ubi Road 1, #06-11 Oxley BizHub 2  
Singapore 408734  
Phone: +65-6391-1833  
Fax: +65-6299-4557  
www.tungaloy.com/sg

### **Tungaloy-NTK Vietnam LLC**

3rd Floor, Licogi 13 Tower, 164 Khuat Duy  
Tien, Nhan Chinh, Thanh Xuan District,  
Hanoi, Vietnam  
Phone: +84 24 63282086  
www.tungaloy.com/vn

### **Tungaloy India Pvt. Ltd.**

One International Center,  
Unit # 902-A, 9th Floor,  
Tower 1, Senapati Bapat Marg,  
Elphinstone Road (West),  
Mumbai 400013, India  
Phone: +91-22-6124-8803  
Fax: +91-22-6124-8899  
www.tungaloy.com/in

### **Tungaloy Korea Co., Ltd**

#1312, Byucksan Digital Valley 5-cha  
Beotkkot-ro 244, Geumcheon-gu  
153-788 Seoul, Korea  
Phone: +82-2-2621-6161  
Fax: +82-2-6393-8952  
www.tungaloy.com/kr

### **Tungaloy Malaysia Sdn Bhd**

50 K-2, Kelana Mall, Jalan SS6/14  
Kelana Jaya, 47301  
Petaling Jaya, Selangor Darul Ehsan  
Malaysia  
Phone: +603-7805-3222  
Fax: +603-7804-8563  
www.tungaloy.com/my

### **Tungaloy Australia Pty Ltd**

Unit 68 1470 Ferntree Gully Road  
Knoxfield 3180 Victoria, Australia  
Phone: +61-3-9755-8147  
Fax: +61-3-9755-6070  
www.tungaloy.com/au

### **PT. Tungaloy Indonesia**

Ruko Blok AA.10 No3&5, Grand Wisata,  
Lambangjaya, Tambun Selatan, Bekasi,  
17510 Indonesia  
Phone: +62-21-8261-5808  
Fax: +62-21-8261-5809  
www.tungaloy.com/id



**tungaloy.com**

follow us at:

facebook.com/tungaloyjapan

twitter.com/tungaloyjapan

www.youtube.com/tungaloycorporation

Distributed by:



Tungaloy APP & SNS

FIND US ON THE CLOUD!  
machingcloud.com



AS9100 Certified  
78006  
2015.11.04  
ISO 14001 Certified  
EC97J1123  
1997.11.26